

## Chapter 6: Periodic Functions

In the previous chapter, the trigonometric functions were introduced as ratios of sides of a triangle, and related to points on a circle. We noticed how the  $x$  and  $y$  values of the points did not change with repeated revolutions around the circle by finding coterminal angles. In this chapter, we will take a closer look at the important characteristics and applications of these types of functions, and begin solving equations involving them.

Section 6.1 Sinusoidal Graphs .....	353
Section 6.2 Graphs of the Other Trig Functions .....	369
Section 6.3 Inverse Trig Functions .....	379
Section 6.4 Solving Trig Equations .....	387
Section 6.5 Modeling with Trigonometric Equations.....	397

### Section 6.1 Sinusoidal Graphs

The London Eye<sup>1</sup> is a huge Ferris wheel with diameter 135 meters (443 feet) in London, England, which completes one rotation every 30 minutes. When we look at the behavior of this Ferris wheel it is clear that it completes 1 cycle, or 1 revolution, and then repeats this revolution over and over again.

This is an example of a periodic function, because the Ferris wheel repeats its revolution or one cycle every 30 minutes, and so we say it has a period of 30 minutes.

In this section, we will work to sketch a graph of a rider's height over time and express the height as a function of time.



#### Periodic Functions

A **periodic function** occurs when a specific horizontal shift,  $P$ , results in the original function; where  $f(x + P) = f(x)$  for all values of  $x$ . When this occurs we call the horizontal shift the **period** of the function.

You might immediately guess that there is a connection here to finding points on a circle, since the height above ground would correspond to the  $y$  value of a point on the circle. We can determine the  $y$  value by using the sine function. To get a better sense of this function's behavior, we can create a table of values we know, and use them to sketch a graph of the sine and cosine functions.

<sup>1</sup> London Eye photo by authors, 2010, CC-BY

Listing some of the values for sine and cosine on a unit circle,

$\theta$	0	$\frac{\pi}{6}$	$\frac{\pi}{4}$	$\frac{\pi}{3}$	$\frac{\pi}{2}$	$\frac{2\pi}{3}$	$\frac{3\pi}{4}$	$\frac{5\pi}{6}$	$\pi$
cos	1	$\frac{\sqrt{3}}{2}$	$\frac{\sqrt{2}}{2}$	$\frac{1}{2}$	0	$-\frac{1}{2}$	$-\frac{\sqrt{2}}{2}$	$-\frac{\sqrt{3}}{2}$	-1
sin	0	$\frac{1}{2}$	$\frac{\sqrt{2}}{2}$	$\frac{\sqrt{3}}{2}$	1	$\frac{\sqrt{3}}{2}$	$\frac{\sqrt{2}}{2}$	$\frac{1}{2}$	0

Here you can see how for each angle, we use the  $y$  value of the point on the circle to determine the output value of the sine function.

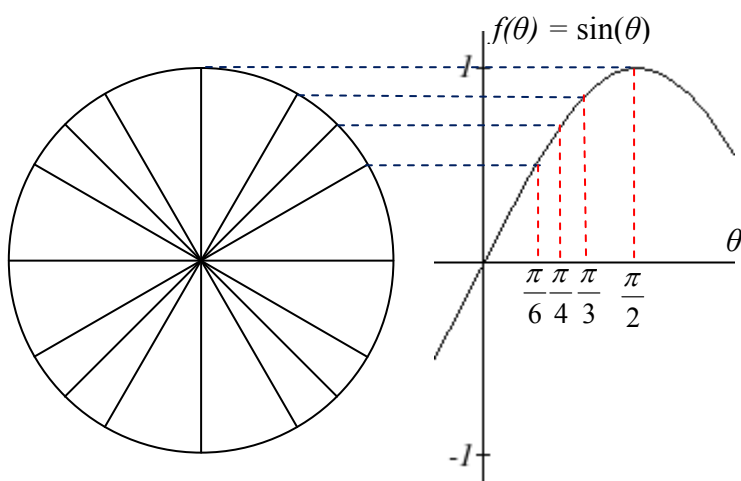

Plotting more points gives the full shape of the sine and cosine functions.

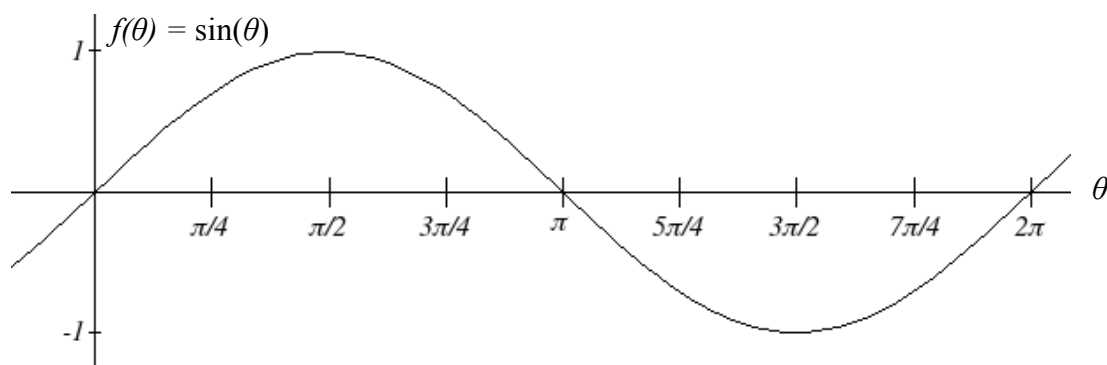

Notice how the sine values are positive between 0 and  $\pi$  which correspond to the values of sine in quadrants 1 and 2 on the unit circle, and the sine values are negative between  $\pi$  and  $2\pi$  representing quadrants 3 and 4.

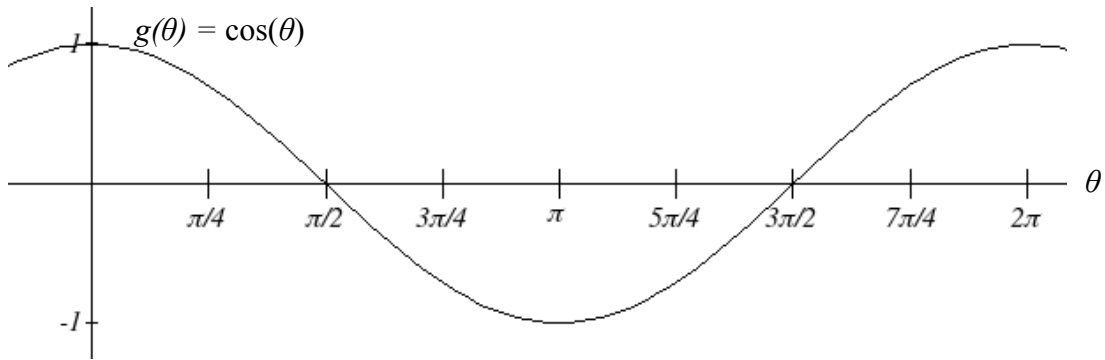

Like the sine function we can track the value of the cosine function through the 4 quadrants of the unit circle as we place it on a graph.

Both of these functions are defined on a domain of all real numbers, since we can evaluate the sine and cosine of any angle. By thinking of sine and cosine as points on a unit circle, it becomes clear that the range of both functions must be the interval  $[-1, 1]$ .

#### Domain and Range of Sine and Cosine

The domain of sine and cosine is all real numbers,  $x \in \mathfrak{R}$  or  $(-\infty, +\infty)$

The range of sine and cosine is the interval  $[-1, 1]$

Both these graphs are considered **sinusoidal** graphs.

In both graphs, the shape of the graph begins repeating after  $2\pi$ . Indeed, since any coterminal angles will have the same sine and cosine values, we could conclude that  $\sin(\theta + 2\pi) = \sin(\theta)$  and  $\cos(\theta + 2\pi) = \cos(\theta)$ .

In other words, if you were to shift either graph horizontally by  $2\pi$ , the resulting shape would be identical to the original function. Sinusoidal functions are a specific type of periodic function.

#### Period of Sine and Cosine

The period is  $2\pi$  for both the sine and cosine function.

Looking at these functions on a domain centered at the vertical axis helps reveal symmetries.

sine

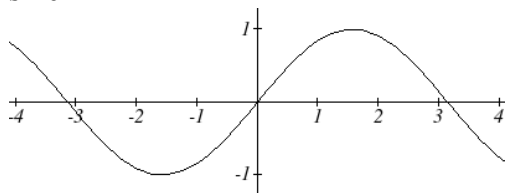

cosine

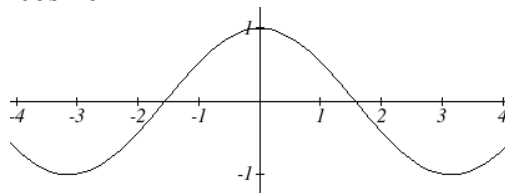

The sine function is symmetric about the origin, the same symmetry the cubic function has, making it an odd function. The cosine function is clearly symmetric about the  $y$  axis, the same symmetry as the quadratic function, making it an even function.

### Negative Angle Identities

The sine is an odd function, symmetric about the *origin*, so  $\sin(-\theta) = -\sin(\theta)$

The cosine is an even function, symmetric about the  $y$ -axis, so  $\cos(-\theta) = \cos(\theta)$

These identities can be used, among other purposes, for helping with simplification and proving identities.

You may recall the cofunction identity from last chapter;  $\sin(\theta) = \cos\left(\frac{\pi}{2} - \theta\right)$ .

Graphically, this tells us that the sine and cosine graphs are horizontal transformations of each other. We can prove this by using the cofunction identity and the negative angle identity for cosine.

$$\sin(\theta) = \cos\left(\frac{\pi}{2} - \theta\right) = \cos\left(-\theta + \frac{\pi}{2}\right) = \cos\left(-\left(\theta - \frac{\pi}{2}\right)\right) = \cos\left(\theta - \frac{\pi}{2}\right)$$

Now we can clearly see that if we horizontally shift the cosine function to the right by  $\pi/2$  we get the sine function.

Remember this shift is not representing the period of the function. It only shows that the cosine and sine function are transformations of each other.

### Example 1

Simplify  $\frac{\sin(-\theta)}{\tan(\theta)}$

$$\frac{\sin(-\theta)}{\tan(\theta)} \quad \text{Using the even/odd identity}$$

$$= \frac{-\sin(\theta)}{\tan(\theta)} \quad \text{Rewriting the tangent}$$

$$= \frac{-\sin(\theta)}{\sin(\theta) / \cos(\theta)} \quad \text{Inverting and multiplying}$$

$$= -\sin(\theta) \cdot \frac{\cos(\theta)}{\sin(\theta)} \quad \text{Simplifying we get}$$

$$= -\cos(\theta)$$

## Transforming Sine and Cosine

### Example 2

A point rotates around a circle of radius 3. Sketch a graph of the  $y$  coordinate of the point.

Recall that for a point on a circle of radius  $r$ , the  $y$  coordinate of the point is  $y = r \sin(\theta)$ , so in this case, we get the equation  $y(\theta) = 3 \sin(\theta)$ .

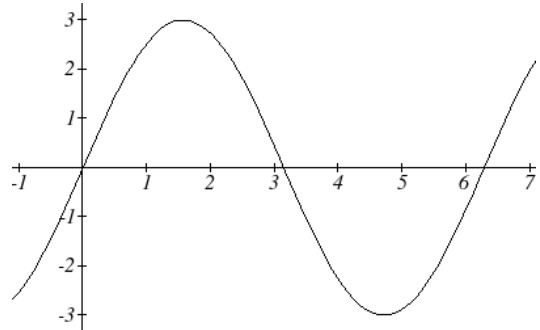

Since the 3 is multiplying the function, this causes a vertical stretch of the  $y$  values of the function by 3.

Notice that the period of the function does not change.

Since the outputs of the graph will now oscillate between -3 and 3, we say that the **amplitude** of the sine wave is 3.

### Try it Now

1. What is the amplitude of the equation  $f(\theta) = 7 \cos(\theta)$ ? Sketch a graph of the function.

### Example 3

A circle with radius 3 feet is mounted with its center 4 feet off the ground. The point closest to the ground is labeled  $P$ . Sketch a graph of the height above ground of the point  $P$  as the circle is rotated, then find an equation for the height.

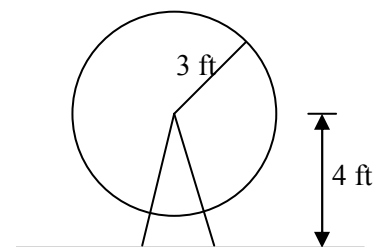

Sketching the height, we note that it will start 1 foot above the ground, then increase up to 7 feet above the ground, and continue to oscillate 3 feet above and below the center value of 4 feet.

Although we could use a transformation of either the sine or cosine function, we start by looking for characteristics that would make one function easier than the other.

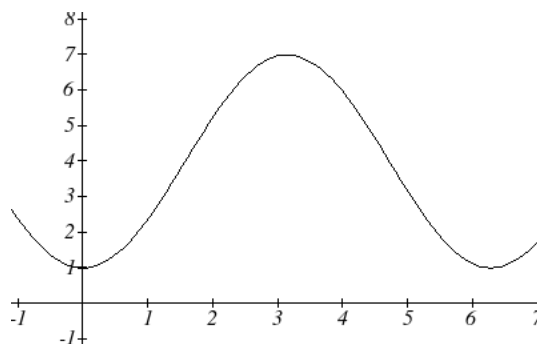

We decide to use a cosine function because it starts at the highest or lowest value, while a sine function starts at the middle value. We know it has been reflected because a standard cosine starts at the highest value, and this graph starts at the lowest value.

Second, we see that the graph oscillates 3 above and below the center, while a basic cosine has an amplitude of one, so this graph has been vertically stretched by 3, as in the last example.

Finally, to move the center of the circle up to a height of 4, the graph has been vertically shifted up by 4. Putting these transformations together,

$$h(\theta) = -3 \cos(\theta) + 4$$

### Midline

The center value of a sinusoidal function, the value that the function oscillates above and below, is called the **midline** of the function, represented by the vertical shift in the equation.

The equation  $f(\theta) = \cos(\theta) + k$  has midline at  $y = k$ .

### Try it Now

2. What is the midline of the equation  $f(\theta) = 3 \cos(\theta) - 4$ ? Sketch a graph of the function.

To answer the Ferris wheel problem at the beginning of the section, we need to be able to express our sine and cosine functions at inputs of time. To do so, we will utilize composition. Since the sine function takes an input of an angle, we will look for a function that takes time as an input and outputs an angle. If we can find a suitable  $\theta(t)$  function, then we can compose this with our  $f(\theta) = \cos(\theta)$  function to obtain a sinusoidal function of time:  $f(t) = \cos(\theta(t))$

## Example 4

A point completes 1 revolution every 2 minutes around circle of radius 5. Find the  $x$  coordinate of the point as a function of time.

Normally, we would express the  $x$  coordinate of a point on a unit circle using  $x = r \cos(\theta)$ , here we write the function  $x(\theta) = 5 \cos(\theta)$ .

The rotation rate of 1 revolution every 2 minutes is an angular velocity. We can use this rate to find a formula for the angle as a function of time. Since the point rotates 1 revolution =  $2\pi$  radians every 2 minutes, it rotates  $\pi$  radians every minute. After  $t$  minutes, it will have rotated:

$$\theta(t) = \pi t \text{ radians}$$

Composing this with the cosine function, we obtain a function of time.

$$x(t) = 5 \cos(\theta(t)) = 5 \cos(\pi t)$$

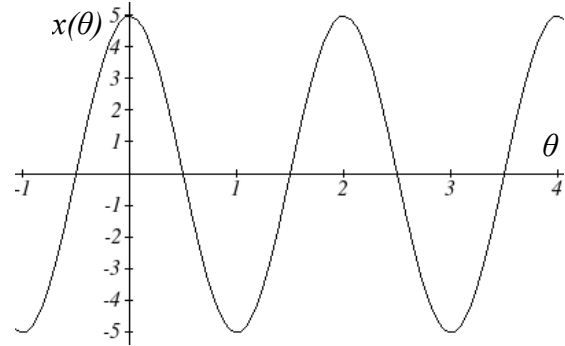

Notice that this composition has the effect of a horizontal compression, changing the period of the function.

To see how the period is related to the stretch or compression coefficient  $B$  in the equation  $f(t) = \sin(Bt)$ , note that the period will be the time it takes to complete one full revolution of a circle. If a point takes  $P$  minutes to complete 1 revolution, then the angular velocity is  $\frac{2\pi \text{ radians}}{P \text{ minutes}}$ . Then  $\theta(t) = \frac{2\pi}{P}t$ . Composing with a sine function,

$$f(t) = \sin(\theta(t)) = \sin\left(\frac{2\pi}{P}t\right)$$

From this, we can determine the relationship between the equation form and the period:

$B = \frac{2\pi}{P}$ . Notice that the stretch or compression coefficient  $B$  is a ratio of the “normal period of a sinusoidal function” to the “new period.” If we know the stretch or compression coefficient  $B$ , we can solve for the “new period”:  $P = \frac{2\pi}{B}$ .

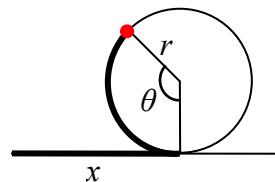

## Example 5

What is the period of the function  $f(t) = \sin\left(\frac{\pi}{6}t\right)$ ?

Using the relationship above, the stretch/compression factor is  $B = \frac{\pi}{6}$ , so the period

$$\text{will be } P = \frac{2\pi}{B} = \frac{2\pi}{\frac{\pi}{6}} = 2\pi \cdot \frac{6}{\pi} = 12.$$

While it is common to compose sine or cosine with functions involving time, the composition can be done so that the input represents any reasonable quantity.

## Example 6

A bicycle wheel with radius 14 inches has the bottom-most point on the wheel marked in red. The wheel then begins rolling down the street. Write a formula for the height above ground of the red point after the bicycle has travelled  $x$  inches.

The height of the point begins at the lowest value, 0, increases to the highest value of 28 inches, and continues to oscillate above and below a center height of 14 inches. In terms of the angle of rotation,  $\theta$ :

$$h(\theta) = -14\cos(\theta) + 14$$

In this case,  $x$  is representing a linear distance the wheel has travelled, corresponding to an arclength along the circle. Since arclength and angle can be related by  $s = r\theta$ , in this case we can write  $x = 14\theta$ , which allows us to express the angle in terms of  $x$ :

$$\theta(x) = \frac{x}{14}$$

Composing this with our cosine-based function from above,

$$h(x) = h(\theta(x)) = -14\cos\left(\frac{x}{14}\right) + 14 = -14\cos\left(\frac{1}{14}x\right) + 14$$

The period of this function would be  $P = \frac{2\pi}{B} = \frac{2\pi}{\frac{1}{14}} = 2\pi \cdot 14 = 28\pi$ , the circumference

of the circle. This makes sense – the wheel completes one full revolution after the bicycle has travelled a distance equivalent to the circumference of the wheel.

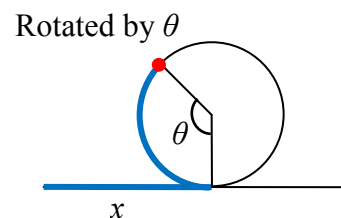
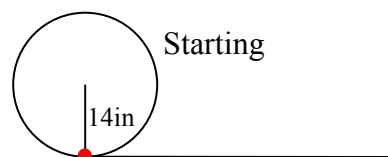



Summarizing our transformations so far:

### Transformations of Sine and Cosine

Given an equation in the form  $f(t) = A\sin(Bt) + k$  or  $f(t) = A\cos(Bt) + k$

$A$  is the vertical stretch, and is the **amplitude** of the function.

$B$  is the horizontal stretch/compression, and is related to the **period,  $P$** , by  $P = \frac{2\pi}{B}$

$k$  is the vertical shift, determines the **midline** of the function

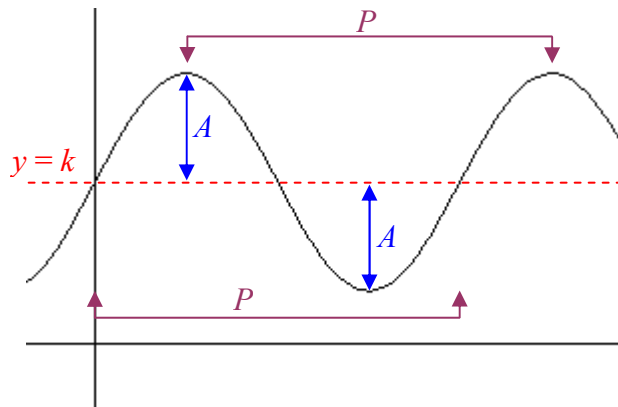

### Example 7

Determine the midline, amplitude, and period of the function  $f(t) = 3\sin(2t) + 1$ .

The amplitude is 3

The period is  $P = \frac{2\pi}{B} = \frac{2\pi}{2} = \pi$

The midline is at  $g(t) = 1$

Amplitude, midline, and period, when combined with vertical flips, are enough to allow us to write equations for a large number of sinusoidal situations.

### Try it Now

- If a sinusoidal function starts on the midline at point  $(0,3)$ , has an amplitude of 2, and a period of 4, write an equation with these features.

## Example 8

Write an equation for the sinusoidal function graphed here.

The graph oscillates from a low of -1 to a high of 3, putting the midline at  $y = 1$ , halfway between.

The amplitude will be 2, the distance from the midline to the highest value (or lowest value) of the graph.

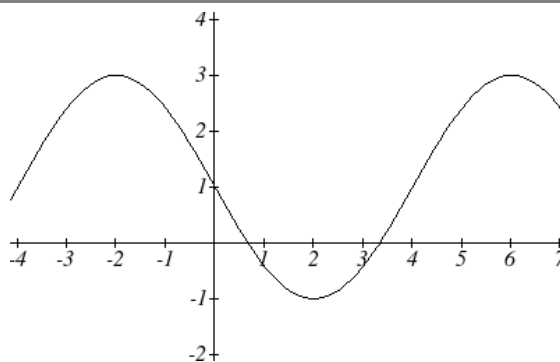

The period of the graph is 8. We can measure this from the first peak at  $x = -2$  to the second at  $x = 6$ . Since the period is 8, the stretch/compression factor we will use will be

$$B = \frac{2\pi}{P} = \frac{2\pi}{8} = \frac{\pi}{4}$$

At  $x = 0$ , the graph is at the midline value, which tells us the graph can most easily be represented as a sine function. Since the graph then decreases, this must be a vertical reflection of the sine function. Putting this all together,

$$f(t) = -2\sin\left(\frac{\pi}{4}t\right) + 1$$

With these transformations, we are ready to answer the Ferris wheel problem from the beginning of the section.

## Example 9

The London Eye is a huge Ferris wheel with diameter 135 meters (443 feet) in London, England, which completes one rotation every 30 minutes. Riders board from a platform 2 meters above the ground. Express a rider's height as a function of time.

With a diameter of 135 meters, the wheel has a radius of 67.5 meters. The height will oscillate with amplitude of 67.5 meters above and below the center.

Passengers board 2 meters above ground level, so the center of the wheel must be located  $67.5 + 2 = 69.5$  meters above ground level. The midline of the oscillation will be at 69.5 meters.

The wheel takes 30 minutes to complete 1 revolution, so the height will oscillate with period of 30 minutes.

Lastly, since the rider boards at the lowest point, the height will start at the smallest value and increase, following the shape of a flipped cosine curve.

Putting these together:

Amplitude: 67.5

Midline: 69.5

Period: 30, so  $B = \frac{2\pi}{30} = \frac{\pi}{15}$

Shape: -cos

An equation for the rider's height would be

$$h(t) = -67.5 \cos\left(\frac{\pi}{15}t\right) + 69.5$$

### Try it Now

4. The Ferris wheel at the Puyallup Fair<sup>2</sup> has a diameter of about 70 feet and takes 3 minutes to complete a full rotation. Passengers board from a platform 10 feet above the ground. Write an equation for a rider's height over time.



While these transformations are sufficient to represent a majority of situations, occasionally we encounter a sinusoidal function that does not have a vertical intercept at the lowest point, highest point, or midline. In these cases, we need to use horizontal shifts. Recall that when the inside of the function is factored, it reveals the horizontal shift.

### Horizontal Shifts of Sine and Cosine

Given an equation in the form  $f(t) = A \sin(B(t-h)) + k$  or  $f(t) = A \cos(B(t-h)) + k$   $h$  is the horizontal shift of the function

### Example 10

Sketch a graph of  $f(t) = 3 \sin\left(\frac{\pi}{4}t - \frac{\pi}{4}\right)$

To reveal the horizontal shift, we first need to factor inside the function:

$$f(t) = 3 \sin\left(\frac{\pi}{4}(t-1)\right)$$

<sup>2</sup> Photo by photogirl7.1, <http://www.flickr.com/photos/kitkaphotogirl/432886205/sizes/z/>, CC-BY

This graph will have the shape of a sine function, starting at the midline and increasing, with an amplitude of 3. The period of the graph will be  $P = \frac{2\pi}{B} = \frac{2\pi}{\frac{\pi}{4}} = 2\pi \cdot \frac{4}{\pi} = 8$ .

Finally, the graph will be shifted to the right by 1.

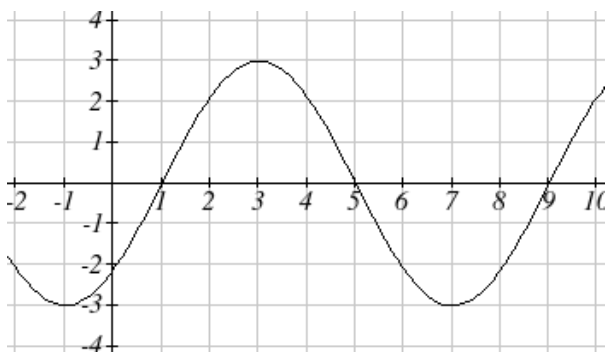

In some physics and mathematics books, you will hear the horizontal shift referred to as **phase shift**. In other physics and mathematics books, they would say the phase shift of the equation above is  $\frac{\pi}{4}$ , the value in the unfactored form. Because of this ambiguity, we will not use the term phase shift any further, and will only talk about the horizontal shift.

### Example 11

Write an equation for the function graphed here.

With highest value at 1 and lowest value at -5, the midline will be halfway between at -2.

The distance from the midline to the highest or lowest value gives an amplitude of 3.

The period of the graph is 6, which can be measured from the peak at  $x = 1$  to the second peak at  $x = 7$ , or from the distance between the lowest points. This gives for our

$$\text{equation } B = \frac{2\pi}{P} = \frac{2\pi}{6} = \frac{\pi}{3}$$

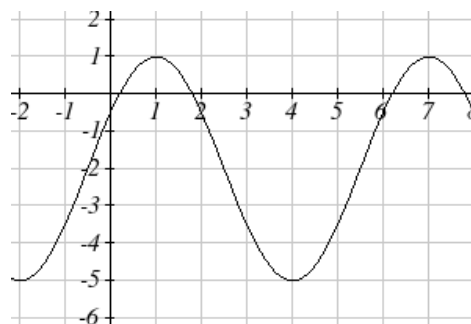

For the shape and shift, we have an option. We could either write this as:

- A cosine shifted 1 to the right
- A negative cosine shifted 2 to the left
- A sine shifted  $\frac{1}{2}$  to the left
- A negative sine shifted 2.5 to the right

While any of these would be fine, the cosine shifts are clearer than the sine shifts in this case, because they are integer values. Writing these:

$$y(x) = 3 \cos\left(\frac{\pi}{3}(x-1)\right) - 2 \quad \text{or}$$

$$y(x) = -3 \cos\left(\frac{\pi}{3}(x+2)\right) - 2$$

Again, these equations are equivalent, so both describe the graph.

### Try it Now

5. Write an equation for the function graphed here.

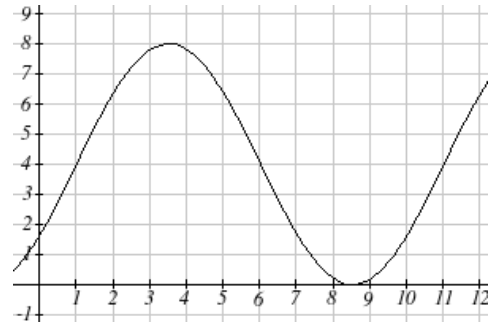

### Important Topics of This Section

Periodic functions  
 Sine & Cosine function from the unit circle  
 Domain and Range of Sine & Cosine function  
 Sinusoidal functions  
 Negative angle identity  
 Simplifying expressions  
 Transformations  
     Amplitude  
     Midline  
     Period  
     Horizontal shifts

### Try it Now Answers

1. 7
2. -4
3.  $f(x) = 2 \sin\left(\frac{\pi}{2}x\right) + 3$
4.  $h(t) = -35 \cos\left(\frac{2\pi}{3}t\right) + 45$
5. Two possibilities:  $f(x) = 4 \cos\left(\frac{\pi}{5}(x-3.5)\right) + 4$  or  $f(x) = 4 \sin\left(\frac{\pi}{5}(x-1)\right) + 4$

**Section 6.1 Exercises**

1. Sketch a graph of  $f(x) = -3\sin(x)$
2. Sketch a graph of  $f(x) = 4\sin(x)$
3. Sketch a graph of  $f(x) = 2\cos(x)$
4. Sketch a graph of  $f(x) = -4\cos(x)$

For the graphs below, determine the amplitude, midline, and period, then write an equation for the graph.

5.

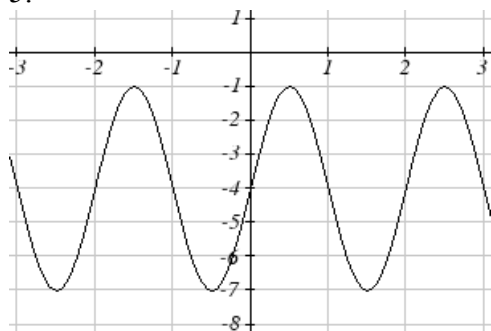

6.

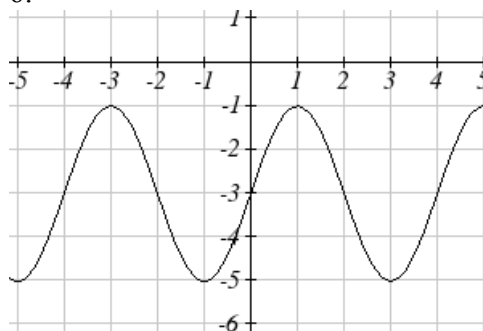

7.

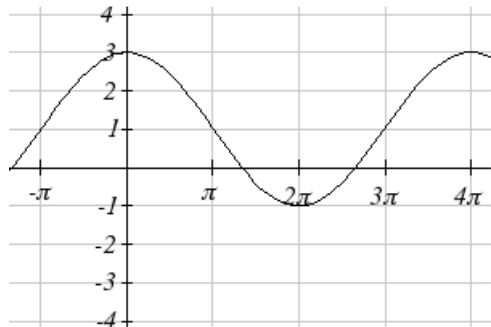

8.

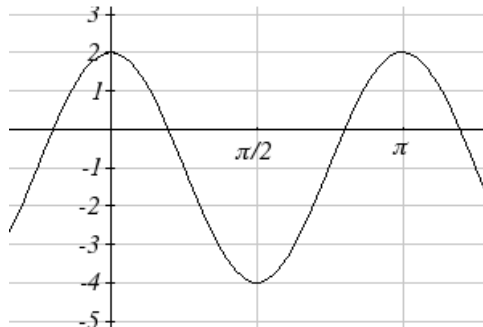

9.

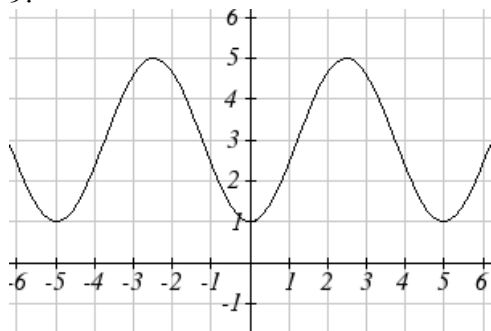

10.

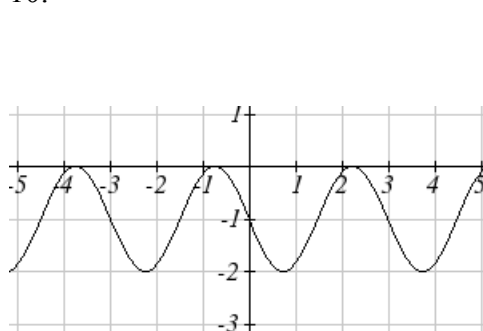

For each of the following equations, find the amplitude, period, horizontal shift, and midline.

11.  $y = 3\sin(8(x+4)) + 5$

12.  $y = 4\sin\left(\frac{\pi}{2}(x-3)\right) + 7$

13.  $y = 2\sin(3x - 21) + 4$

14.  $y = 5\sin(5x + 20) - 2$

15.  $y = \sin\left(\frac{\pi}{6}x + \pi\right) - 3$

16.  $y = 8\sin\left(\frac{7\pi}{6}x + \frac{7\pi}{2}\right) + 6$

Find a formula for each of the graphs shown below.

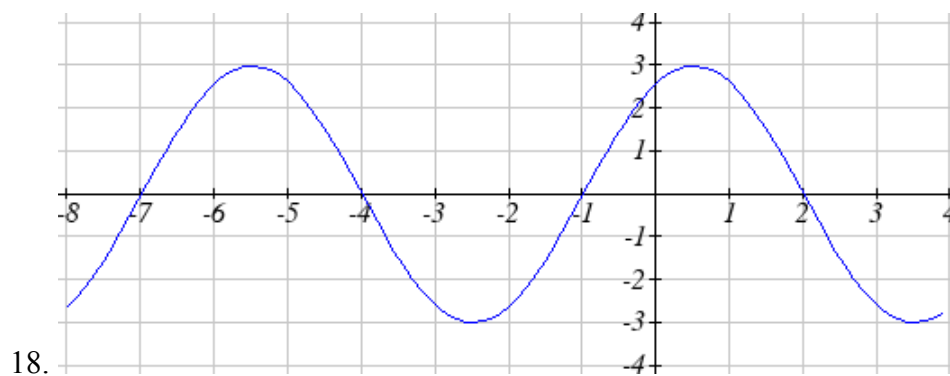
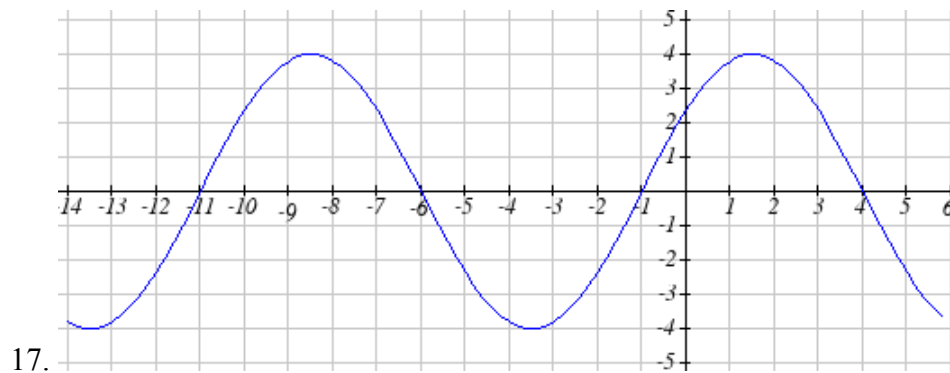

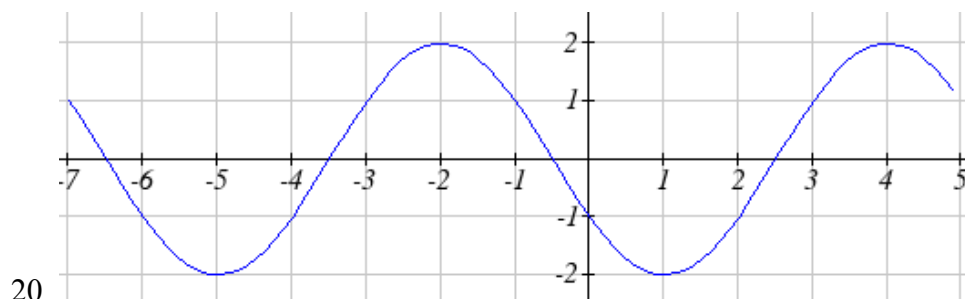
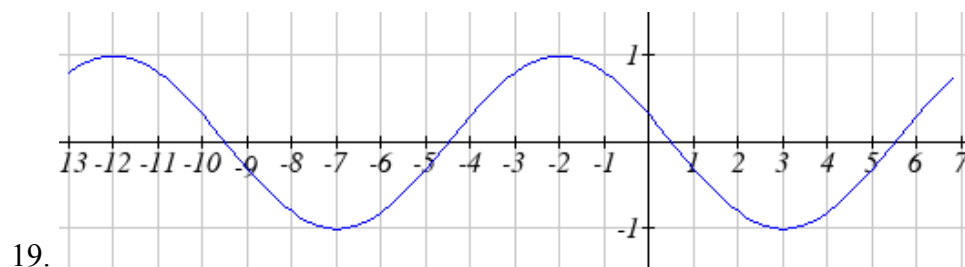

21. Outside temperature over a day can be modeled as a sinusoidal function. Suppose you know the temperature is 50 degrees at midnight and the high and low temperature during the day are 57 and 43 degrees, respectively. Assuming  $t$  is the number of hours since midnight, find an equation for the temperature,  $D$ , in terms of  $t$ .
22. Outside temperature over a day can be modeled as a sinusoidal function. Suppose you know the temperature is 68 degrees at midnight and the high and low temperature during the day are 80 and 56 degrees, respectively. Assuming  $t$  is the number of hours since midnight, find an equation for the temperature,  $D$ , in terms of  $t$ .
23. A Ferris wheel is 25 meters in diameter and boarded from a platform that is 1 meters above the ground. The six o'clock position on the Ferris wheel is level with the loading platform. The wheel completes 1 full revolution in 10 minutes. The function  $h(t)$  gives your height in meters above the ground  $t$  minutes after the wheel begins to turn.
- Find the amplitude, midline, and period of  $h(t)$
  - Find an equation for the height function  $h(t)$
  - How high are you off the ground after 5 minutes?
24. A Ferris wheel is 35 meters in diameter and boarded from a platform that is 3 meters above the ground. The six o'clock position on the Ferris wheel is level with the loading platform. The wheel completes 1 full revolution in 8 minutes. The function  $h(t)$  gives your height in meters above the ground  $t$  minutes after the wheel begins to turn.
- Find the amplitude, midline, and period of  $h(t)$
  - Find an equation for the height function  $h(t)$
  - How high are you off the ground after 4 minutes?



## Section 6.2 Graphs of the Other Trig Functions

In this section, we will explore the graphs of the other four trigonometric functions. We'll begin with the tangent function. Recall that in chapter 5 we defined tangent as  $y/x$  or sine/cosine, so you can think of the tangent as the slope of a line from the origin at the given angle. At an angle of 0, the line would be horizontal with a slope of zero. As the angle increases towards  $\pi/2$ , the slope increases more and more. At an angle of  $\pi/2$ , the line would be vertical and the slope would be undefined. Immediately past  $\pi/2$ , the line would be decreasing and very steep giving a large negative tangent value. There is a break in the function at  $\pi/2$ , where the tangent value jumps from large positive to large negative.

We can use these ideas along with the definition of tangent to sketch a graph. Since tangent is defined as sine/cosine, we can determine that tangent will be zero when sine is zero: at  $-\pi$ , 0,  $\pi$ , and so on. Likewise, tangent will be undefined when cosine is zero: at  $-\pi/2$ ,  $\pi/2$ , and so on.

The tangent is positive from 0 to  $\pi/2$  and  $\pi$  to  $3\pi/2$ , corresponding to quadrants 1 and 3 of the unit circle.

Using technology, we can obtain a graph of tangent on a standard grid.

Notice that the graph appears to repeat itself. For any angle on the circle, there is a second angle with the same slope and tangent value halfway around the circle, so the graph repeats itself with a period of  $\pi$ ; we can see one continuous cycle from  $-\pi/2$  to  $\pi/2$ , before it jumps & repeats itself.

The graph has vertical asymptotes and the tangent is undefined wherever a line at the angle would be vertical – at  $\pi/2$ ,  $3\pi/2$ , and so on. While the domain of the function is limited in this way, the range of the function is all real numbers.

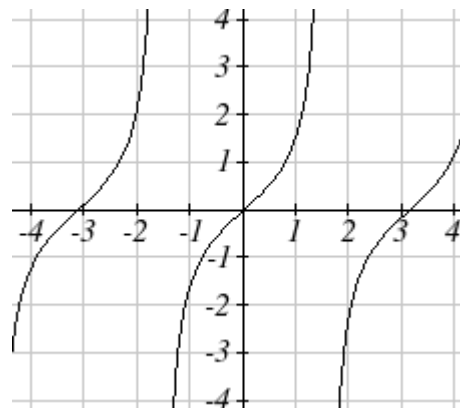
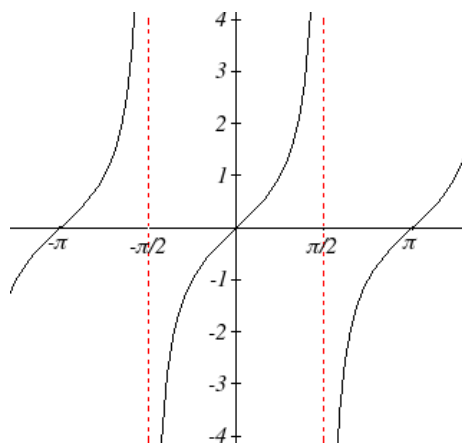

### Features of the Graph of Tangent

The **graph of the tangent function**  $m(\theta) = \tan(\theta)$

The **period** of the tangent function is  $\pi$

The **domain** of the tangent function is  $\theta \neq \frac{\pi}{2} + k\pi$ , where  $k$  is an integer

The **range** of the tangent function is all real numbers,  $x \in \mathbb{R}$  or  $(-\infty, +\infty)$

With the tangent function, like the sine and cosine functions, horizontal stretches/compressions are distinct from vertical stretches/compressions. The horizontal stretch can typically be determined from the period of the graph. With tangent graphs, it is often necessary to solve for a vertical stretch using a point on the graph.

### Example 1

Write an equation for the function graphed here.

The graph has the shape of a tangent function, however the period appears to be 8. We can see one full continuous cycle from -4 to 4, suggesting a horizontal stretch. To stretch  $\pi$  to 8, the input values would have to be

multiplied by  $\frac{8}{\pi}$ . Since the value in the

equation to give this stretch is the reciprocal, the equation must have form

$$f(\theta) = a \tan\left(\frac{\pi}{8}\theta\right)$$

We can also think of this the same way we did with sine and cosine. The period of the tangent function is  $\pi$  but it has been transformed and now it is 8, remember the ratio of the “normal period” to the “new period” is  $\frac{\pi}{8}$  and so this becomes the value on the inside of the function that tells us how it was horizontally stretched.

To find the vertical stretch  $a$ , we can use a point on the graph. Using the point (2, 2)

$$2 = a \tan\left(\frac{\pi}{8} \cdot 2\right) = a \tan\left(\frac{\pi}{4}\right). \text{ Since } \tan\left(\frac{\pi}{4}\right) = 1, \quad a = 2$$

This graph would have equation  $f(\theta) = 2 \tan\left(\frac{\pi}{8}\theta\right)$

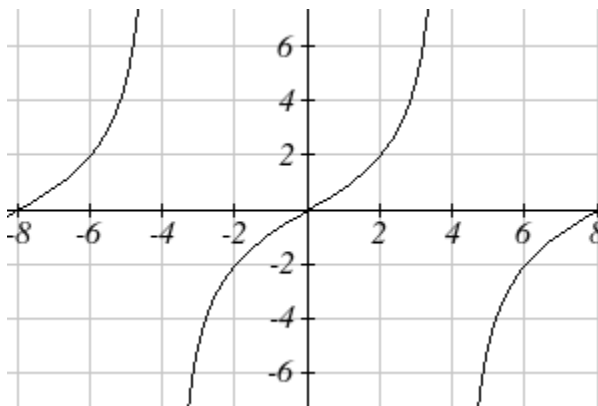

### Try it Now

1. Sketch a graph of  $f(\theta) = 3 \tan\left(\frac{\pi}{6}\theta\right)$

For the graph of secant, we remember the reciprocal identity where  $\sec(\theta) = \frac{1}{\cos(\theta)}$ .

Notice that the function is undefined when the cosine is 0, leading to a vertical asymptote in the graph at  $\pi/2, 3\pi/2$ , etc. Since the cosine is always less than one in absolute value, the secant, being the reciprocal, will always be greater than one in absolute value. Using technology, we can generate the graph. The graph of the cosine is shown dashed so you can see the relationship.

$$f(\theta) = \sec(\theta) = \frac{1}{\cos(\theta)}$$

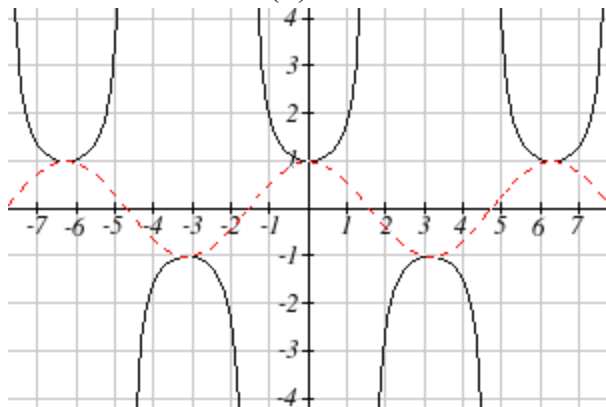

The graph of cosecant is similar. In fact, since  $\sin(\theta) = \cos\left(\frac{\pi}{2} - \theta\right)$ , it follows that

$$\csc(\theta) = \sec\left(\frac{\pi}{2} - \theta\right),$$

suggesting the cosecant graph is a horizontal shift of the secant graph.

This graph will be undefined where sine is 0. Recall from the unit circle that this occurs at  $0, \pi, 2\pi$ , etc. The graph of sine is shown dashed along with the graph of the cosecant.

$$f(\theta) = \csc(\theta) = \frac{1}{\sin(\theta)}$$

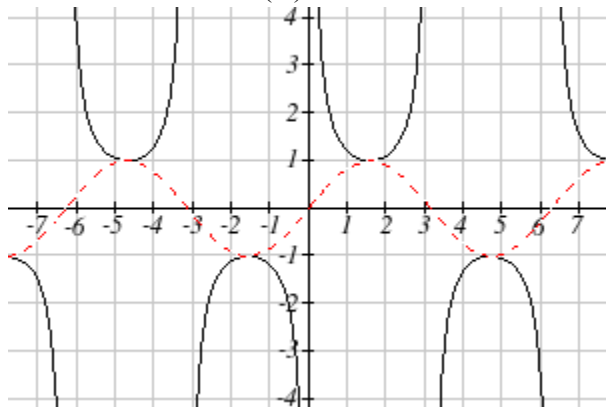

### Features of the Graph of Secant and Cosecant

The secant and cosecant graphs have period  $2\pi$  like the sine and cosine functions.

Secant has domain  $\theta \neq \frac{\pi}{2} + k\pi$ , where  $k$  is an integer

Cosecant has domain  $\theta \neq k\pi$ , where  $k$  is an integer

Both secant and cosecant have range of  $(-\infty, -1] \cup [1, \infty)$

### Example 2

Sketch a graph of  $f(\theta) = 2 \csc\left(\frac{\pi}{2}\theta\right) + 1$ . What is the domain and range of this function?

The basic cosecant graph has vertical asymptotes at the multiples of  $\pi$ . Because of the factor  $\frac{\pi}{2}$  in the equation, the graph will be compressed by  $\frac{2}{\pi}$ , so the vertical asymptotes will be compressed to  $\theta = \frac{2}{\pi} \cdot k\pi = 2k$ . In other words, the graph will have vertical asymptotes at the multiples of 2, and the domain will correspondingly be  $\theta \neq 2k$ , where  $k$  is an integer.

The basic sine graph has a range of  $[-1, 1]$ . The vertical stretch by 2 will stretch this to  $[-2, 2]$ , and the vertical shift up 1 will shift the range of this function to  $[-1, 3]$ .

The basic cosecant graph has a range of  $(-\infty, -1] \cup [1, \infty)$ . The vertical stretch by 2 will stretch this to  $(-\infty, -2] \cup [2, \infty)$ , and the vertical shift up 1 will shift the range of this function to  $(-\infty, -1] \cup [3, \infty)$

Sketching a graph,

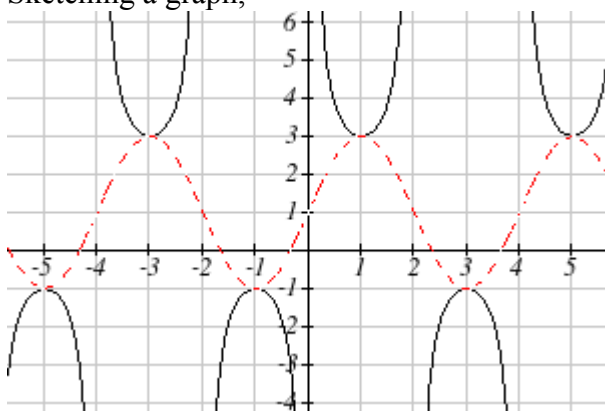

Notice how the graph of the transformed cosecant relates to the graph of

$f(\theta) = 2 \sin\left(\frac{\pi}{2}\theta\right) + 1$  shown dashed.

## Try it Now

2. Given the graph  $f(\theta) = 2\cos\left(\frac{\pi}{2}\theta\right) + 1$

shown, sketch the graph of

$g(\theta) = 2\sec\left(\frac{\pi}{2}\theta\right) + 1$  on the same axes.

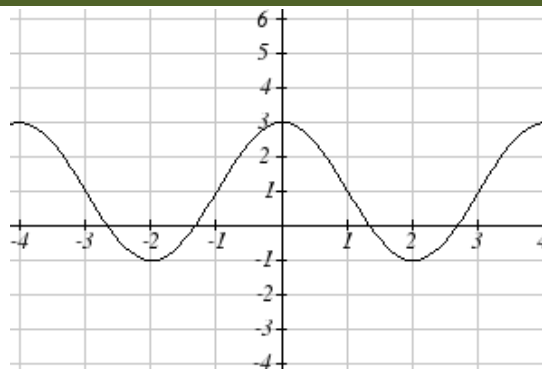

Finally, we'll look at the graph of cotangent. Based on its definition as the ratio of cosine to sine, it will be undefined when the sine is zero – at  $0, \pi, 2\pi$ , etc. The resulting graph is similar to that of the tangent. In fact, it is horizontal flip and shift of the tangent function.

$$f(\theta) = \cot(\theta) = \frac{1}{\tan(\theta)} = \frac{\cos(\theta)}{\sin(\theta)}$$

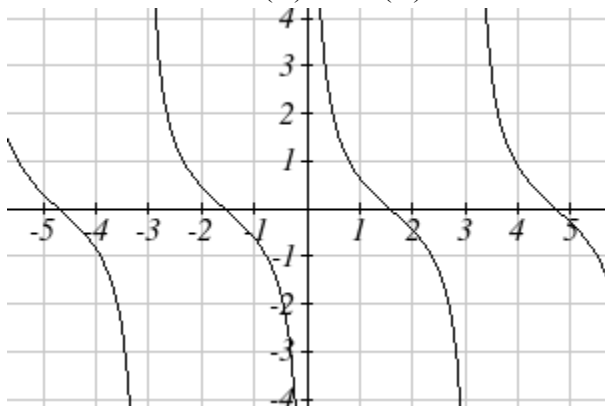

## Features of the Graph of Cotangent

The cotangent graph has period  $\pi$

Cotangent has domain  $\theta \neq k\pi$ , where  $k$  is an integer

Cotangent has range of all real numbers,  $x \in \mathfrak{R}$  or  $(-\infty, +\infty)$

In 6.1 we determined that the sine function was an odd function and the cosine was an even function by observing the graph, establishing the negative angle identities for cosine and sine. Similarly, you may notice that the graph of the tangent function appears to be odd. We can verify this using the negative angle identities for sine and cosine:

$$\tan(-\theta) = \frac{\sin(-\theta)}{\cos(-\theta)} = \frac{-\sin(\theta)}{\cos(\theta)} = -\tan(\theta)$$

The secant, like the cosine it is based on, is an even function, while the cosecant, like the sine, is an odd function.

### Negative Angle Identities Tangent, Cotangent, Secant and Cosecant

$$\tan(-\theta) = -\tan(\theta) \qquad \cot(-\theta) = -\cot(\theta)$$

$$\sec(-\theta) = \sec(\theta) \qquad \csc(-\theta) = -\csc(\theta)$$

### Example 3

Prove that  $\tan(\theta) = -\cot\left(\theta - \frac{\pi}{2}\right)$

$\tan(\theta)$	Using the definition of tangent
$= \frac{\sin(\theta)}{\cos(\theta)}$	Using the cofunction identities
$= \frac{\cos\left(\frac{\pi}{2} - \theta\right)}{\sin\left(\frac{\pi}{2} - \theta\right)}$	Using the definition of cotangent
$= \cot\left(\frac{\pi}{2} - \theta\right)$	Factoring a negative from the inside
$= \cot\left(-\left(\theta - \frac{\pi}{2}\right)\right)$	Using the negative angle identity for cot
$= -\cot\left(\theta - \frac{\pi}{2}\right)$	

### Important Topics of This Section

The tangent and cotangent functions

Period  
Domain  
Range

The secant and cosecant functions

Period  
Domain  
Range

Transformations

Negative Angle identities

## Try it Now Answers

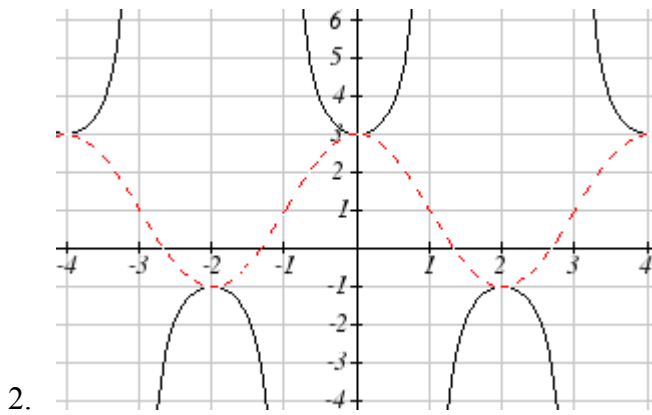
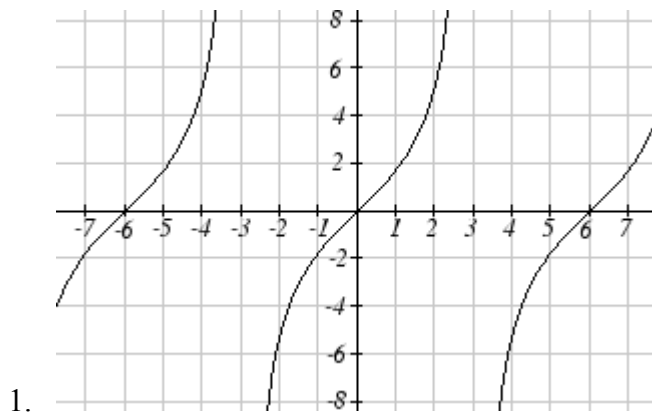

### Section 6.2 Exercises

Match the trigonometric function with one of the graphs

1.  $f(x) = \tan(x)$                       2.  $f(x) = \sec(x)$

3.  $f(x) = \csc(x)$                       4.  $f(x) = \cot(x)$

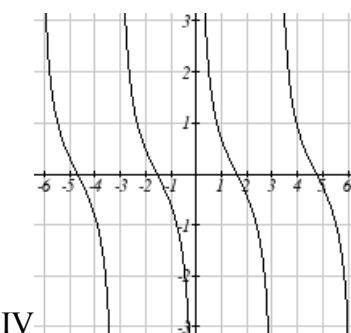
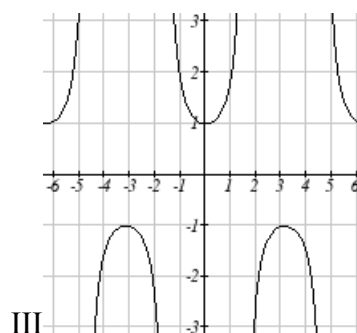
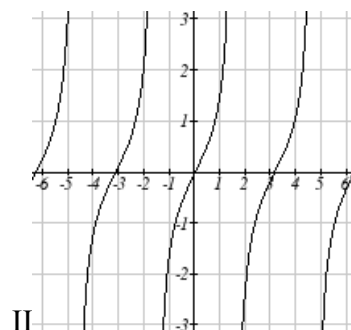
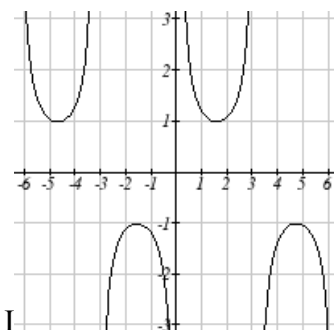

Find the period and horizontal shift of each of the following functions.

5.  $f(x) = 2 \tan(4x - 32)$

6.  $g(x) = 3 \tan(6x + 42)$

7.  $h(x) = 2 \sec\left(\frac{\pi}{4}(x+1)\right)$

8.  $k(x) = 3 \sec\left(2\left(x + \frac{\pi}{2}\right)\right)$

9.  $m(x) = 6 \csc\left(\frac{\pi}{3}x + \pi\right)$

10.  $n(x) = 4 \csc\left(\frac{5\pi}{3}x - \frac{20\pi}{3}\right)$



11. Sketch a graph of #7 above
12. Sketch a graph of #8 above
13. Sketch a graph of #9 above
14. Sketch a graph of #10 above

15. Sketch a graph of  $j(x) = \tan\left(\frac{\pi}{2}x\right)$

16. Sketch a graph of  $p(t) = 2 \tan\left(t - \frac{\pi}{2}\right)$

Write an equation for each of the graphs shown

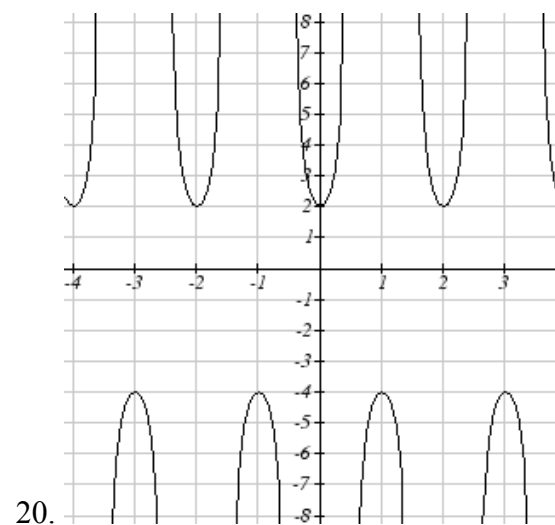
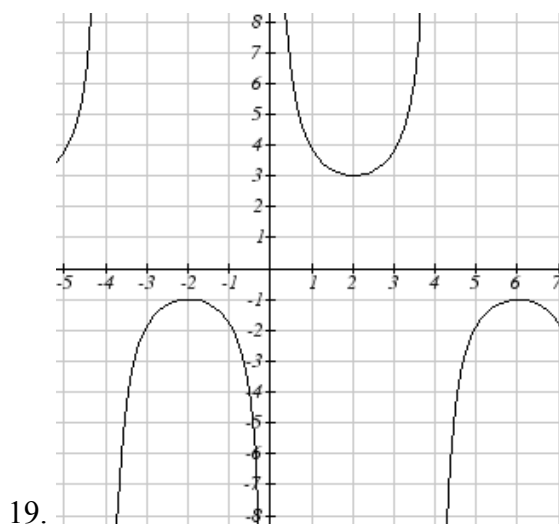
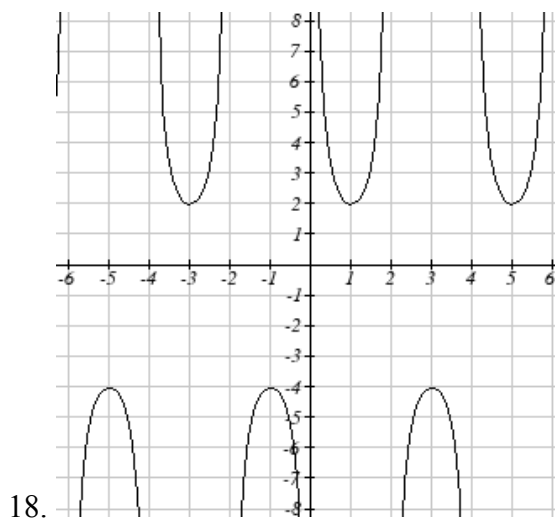
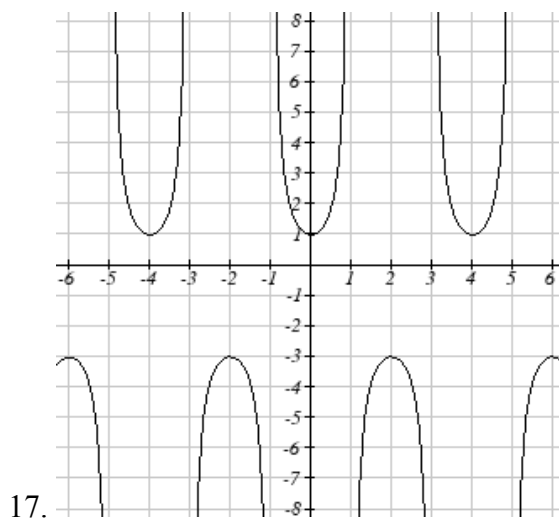

21. If  $\tan x = -1.5$ , find  $\tan(-x)$

22. If  $\tan x = 3$ , find  $\tan(-x)$

23. If  $\sec x = 2$ , find  $\sec(-x)$

24. If  $\sec x = -4$ , find  $\sec(-x)$

25. If  $\csc x = -5$ , find  $\csc(-x)$

26. If  $\csc x = 2$ , find  $\csc(-x)$

Simplify each of the following expressions completely

27.  $\cot(-x)\cos(-x) + \sin(-x)$

28.  $\cos(-x) + \tan(-x)\sin(-x)$

## Section 6.3 Inverse Trig Functions

While in the previous sections we have evaluated the trigonometric functions, at times we need to know what angle would give a specific sine, cosine, or tangent value. For this, we need an inverse. Recall that for a one-to-one function, if  $f(a) = b$ , then an inverse function would satisfy  $f^{-1}(b) = a$ .

You probably are already recognizing an issue – that the sine, cosine, and tangent functions are not one-to-one functions. To define an inverse of these functions, we will need to restrict the domain of these functions to so that they *are* one-to-one. We choose a domain for each function which includes the angle of zero.

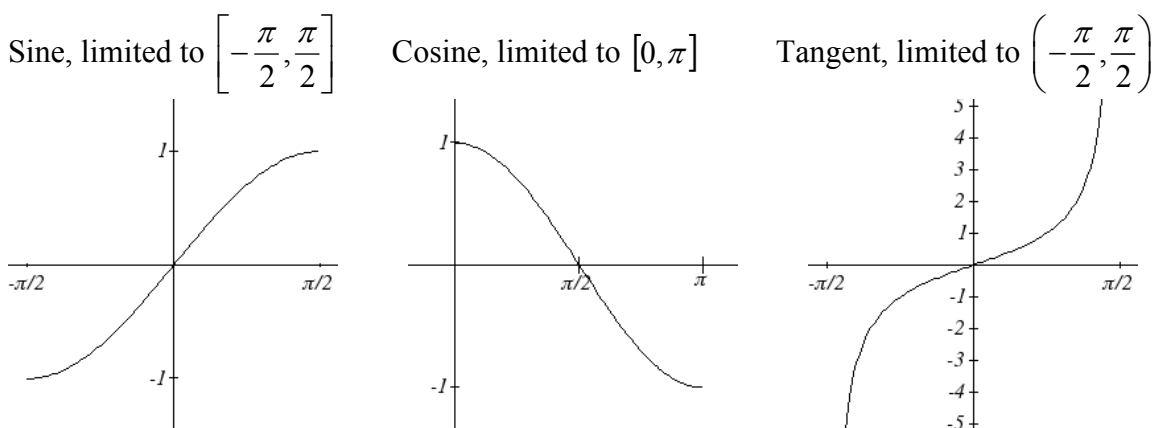

On these restricted domains, we can define the inverse sine and cosine and tangent functions.

### Inverse Sine, Cosine, and Tangent Functions

For angles in the interval  $\left[-\frac{\pi}{2}, \frac{\pi}{2}\right]$ , if  $\sin(\theta) = a$ , then  $\sin^{-1}(a) = \theta$

For angles in the interval  $[0, \pi]$ , if  $\cos(\theta) = a$ , then  $\cos^{-1}(a) = \theta$

For angles in the interval  $\left(-\frac{\pi}{2}, \frac{\pi}{2}\right)$ , if  $\tan(\theta) = a$ , then  $\tan^{-1}(a) = \theta$

$\sin^{-1}(x)$  has domain  $[-1, 1]$  and range  $\left[-\frac{\pi}{2}, \frac{\pi}{2}\right]$

$\cos^{-1}(x)$  has domain  $[-1, 1]$  and range  $[0, \pi]$

$\tan^{-1}(x)$  has domain of all real numbers and range  $\left(-\frac{\pi}{2}, \frac{\pi}{2}\right)$

The  $\sin^{-1}(x)$  is sometimes called the **arcsine** function, and notated  $\arcsin(a)$

The  $\cos^{-1}(x)$  is sometimes called the **arccosine** function, and notated  $\arccos(a)$

The  $\tan^{-1}(x)$  is sometimes called the **arctangent** function, and notated  $\arctan(a)$

The graphs of the inverse functions are shown here.

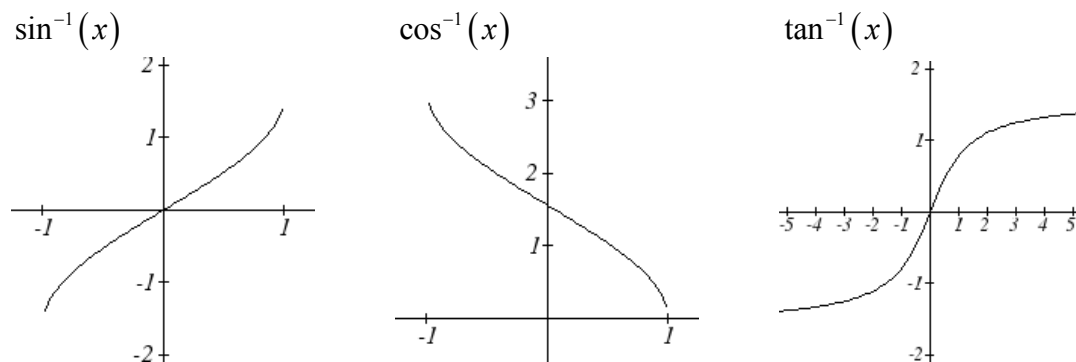

Notice that the output of the inverse functions is an *angle*.

### Example 1

Evaluate

a)  $\sin^{-1}\left(\frac{1}{2}\right)$       b)  $\sin^{-1}\left(-\frac{\sqrt{2}}{2}\right)$       c)  $\cos^{-1}\left(-\frac{\sqrt{3}}{2}\right)$       d)  $\tan^{-1}(1)$

a) Evaluating  $\sin^{-1}\left(\frac{1}{2}\right)$  is the same as asking what angle would have a sine value of  $\frac{1}{2}$ .

In other words, what angle  $\theta$  would satisfy  $\sin(\theta) = \frac{1}{2}$ ? There are multiple angles that would satisfy this relationship, such as  $\frac{\pi}{6}$  and  $\frac{5\pi}{6}$ , but we know we need the angle in the interval  $\left[-\frac{\pi}{2}, \frac{\pi}{2}\right]$ , so the answer will be  $\sin^{-1}\left(\frac{1}{2}\right) = \frac{\pi}{6}$ . Remember that the inverse is a *function* so for each input, we will get exactly one output.

b) Evaluating  $\sin^{-1}\left(-\frac{\sqrt{2}}{2}\right)$ , we know that  $\frac{5\pi}{4}$  and  $\frac{7\pi}{4}$  both have a sine value of  $-\frac{\sqrt{2}}{2}$ , but neither is in the interval  $\left[-\frac{\pi}{2}, \frac{\pi}{2}\right]$ . For that, we need the negative angle coterminal with  $\frac{7\pi}{4}$ .  $\sin^{-1}\left(-\frac{\sqrt{2}}{2}\right) = -\frac{\pi}{4}$

c) Evaluating  $\cos^{-1}\left(-\frac{\sqrt{3}}{2}\right)$ , we are looking for an angle in the interval  $[0, \pi]$  with a cosine value of  $-\frac{\sqrt{3}}{2}$ . The angle that satisfies this is  $\cos^{-1}\left(-\frac{\sqrt{3}}{2}\right) = \frac{5\pi}{6}$

d) Evaluating  $\tan^{-1}(1)$ , we are looking for an angle in the interval  $\left(-\frac{\pi}{2}, \frac{\pi}{2}\right)$  with a tangent value of 1. The correct angle is  $\tan^{-1}(1) = \frac{\pi}{4}$

### Try It Now

1. Evaluate

a)  $\sin^{-1}(-1)$

b)  $\tan^{-1}(-1)$

c)  $\cos^{-1}(-1)$

d)  $\cos^{-1}\left(\frac{1}{2}\right)$

### Example 2

Evaluate  $\sin^{-1}(0.97)$  using your calculator

Since the output of the inverse function is an angle, your calculator will give you a degree angle if in degree mode, and a radian value if in radian mode.

In radian mode,  $\sin^{-1}(0.97) \approx 1.3252$       In degree mode,  $\sin^{-1}(0.97) \approx 75.93^\circ$

### Try it Now

2. Evaluate  $\cos^{-1}(-0.4)$  using your calculator

In section 5.5, we worked with trigonometry on a right triangle to solve for the sides of a triangle given one side and an additional angle. Using the inverse trig functions, we can solve for the angles of a right triangle given two sides.

### Example 3

Solve the triangle for the angle  $\theta$

Since we know the hypotenuse and side adjacent to the angle, it makes sense for us to use the cosine function.

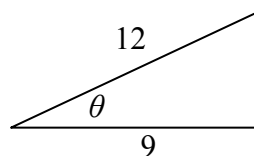

$$\sin(\theta) = \frac{9}{12} \quad \text{Using the definition of the inverse,}$$

$$\theta = \sin^{-1}\left(\frac{9}{12}\right) \quad \text{Evaluating}$$

$$\theta \approx 0.8481, \text{ or about } 48.5904^\circ$$

There are times when we need to compose a trigonometric function with an inverse trigonometric function. In these cases, we can find exact values for the resulting expressions

#### Example 4

$$\text{Evaluate } \sin^{-1}\left(\cos\left(\frac{13\pi}{6}\right)\right)$$

a) Here, we can directly evaluate the inside of the composition.

$$\cos\left(\frac{13\pi}{6}\right) = \frac{\sqrt{3}}{2}$$

Now, we can evaluate the inverse function as we did earlier.

$$\sin^{-1}\left(\frac{\sqrt{3}}{2}\right) = \frac{\pi}{3}$$

#### Try it Now

$$3. \text{ Evaluate } \cos^{-1}\left(\sin\left(-\frac{11\pi}{4}\right)\right)$$

#### Example 5

$$\text{Find an exact value for } \sin\left(\cos^{-1}\left(\frac{4}{5}\right)\right)$$

Beginning with the inside, we can say there is some angle so  $\theta = \cos^{-1}\left(\frac{4}{5}\right)$ , which

means  $\cos(\theta) = \frac{4}{5}$ , and we are looking for  $\sin(\theta)$ . We can use the Pythagorean identity to do this.

$$\sin^2(\theta) + \cos^2(\theta) = 1$$

Using our known value for cosine

$$\sin^2(\theta) + \left(\frac{4}{5}\right)^2 = 1$$

Solving for sine

$$\sin^2(\theta) = 1 - \frac{16}{25}$$

$$\sin(\theta) = \pm\sqrt{\frac{9}{25}} = \pm\frac{3}{5}$$

Since we know that the cosine inverse always gives an angle on the interval  $[0, \pi]$ , we know that the sine of that angle must be positive, so  $\sin\left(\cos^{-1}\left(\frac{4}{5}\right)\right) = \sin(\theta) = \frac{3}{5}$

### Example 6

Find an exact value for  $\sin\left(\tan^{-1}\left(\frac{7}{4}\right)\right)$

While we could use a similar technique as in the last example, we will demonstrate a different technique here. From the inside, we know there is an angle so  $\tan(\theta) = \frac{7}{4}$ . We can envision this as the opposite and adjacent sides on a right triangle.

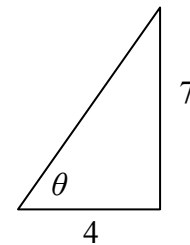

Using Pythagorean theorem, we can find the hypotenuse of this triangle:

$$4^2 + 7^2 = \text{hypotenuse}^2$$

$$\text{hypotenuse} = \sqrt{65}$$

Now, we can evaluate the sine of the angle as side opposite divided by hypotenuse

$$\sin(\theta) = \frac{7}{\sqrt{65}}$$

This gives us our desired composition

$$\sin\left(\tan^{-1}\left(\frac{7}{4}\right)\right) = \sin(\theta) = \frac{7}{\sqrt{65}}$$

### Try it Now

4. Evaluate  $\cos\left(\sin^{-1}\left(\frac{7}{9}\right)\right)$

We can also find compositions involving algebraic expressions.

### Example 7

Find a simplified expression for  $\cos\left(\sin^{-1}\left(\frac{x}{3}\right)\right)$ , for  $-3 \leq x \leq 3$

We know there is an angle so  $\sin(\theta) = \frac{x}{3}$ . Using Pythagorean Theorem,

$$\sin^2(\theta) + \cos^2(\theta) = 1 \quad \text{Using our known expression for sine}$$

$$\left(\frac{x}{3}\right)^2 + \cos^2(\theta) = 1 \quad \text{Solving for cosine}$$

$$\cos^2(\theta) = 1 - \frac{x^2}{9}$$

$$\cos(\theta) = \pm \sqrt{\frac{9-x^2}{9}} = \pm \frac{\sqrt{9-x^2}}{3}$$

Since we know that the sine inverse must give an angle on the interval  $\left[-\frac{\pi}{2}, \frac{\pi}{2}\right]$ , we can deduce that the cosine of that angle must be positive. This gives us

$$\cos\left(\sin^{-1}\left(\frac{x}{3}\right)\right) = \frac{\sqrt{9-x^2}}{3}$$

### Try it Now

5. Find a simplified expression for  $\sin(\tan^{-1}(4x))$ , for  $-\frac{1}{4} \leq x \leq \frac{1}{4}$

### Important Topics of This Section

Inverse trig functions: arcsine, arccosine and arctangent

Domain restrictions

Evaluating inverses using unit circle values and the calculator

Simplifying numerical expressions involving the inverse trig functions

Simplifying algebraic expressions involving the inverse trig functions



## Try it Now Answers

1. a)  $-\frac{\pi}{2}$  b)  $-\frac{\pi}{4}$  c)  $\pi$  d)  $\frac{\pi}{3}$

2. 1.9823 or  $\approx 113.578$

3.  $\frac{3\pi}{4}$

4.  $\frac{4\sqrt{2}}{9}$

5.  $\frac{4x}{\sqrt{16x^2 + 1}}$

**Section 6.3 Exercises**

Evaluate the following expressions

- |                                               |                                               |                                                |                                                |
|-----------------------------------------------|-----------------------------------------------|------------------------------------------------|------------------------------------------------|
| 1. $\sin^{-1}\left(\frac{\sqrt{2}}{2}\right)$ | 2. $\sin^{-1}\left(\frac{\sqrt{3}}{2}\right)$ | 3. $\sin^{-1}\left(-\frac{1}{2}\right)$        | 4. $\sin^{-1}\left(-\frac{\sqrt{2}}{2}\right)$ |
| 5. $\cos^{-1}\left(\frac{1}{2}\right)$        | 6. $\cos^{-1}\left(\frac{\sqrt{2}}{2}\right)$ | 7. $\cos^{-1}\left(-\frac{\sqrt{2}}{2}\right)$ | 8. $\cos^{-1}\left(-\frac{\sqrt{3}}{2}\right)$ |
| 9. $\tan^{-1}(1)$                             | 10. $\tan^{-1}(\sqrt{3})$                     | 11. $\tan^{-1}(-\sqrt{3})$                     | 12. $\tan^{-1}(-1)$                            |

Use your calculator to evaluate each expression

- |                       |                      |                       |                    |
|-----------------------|----------------------|-----------------------|--------------------|
| 13. $\cos^{-1}(-0.4)$ | 14. $\cos^{-1}(0.8)$ | 15. $\sin^{-1}(-0.8)$ | 16. $\tan^{-1}(6)$ |
|-----------------------|----------------------|-----------------------|--------------------|

Solve the triangle for the angle

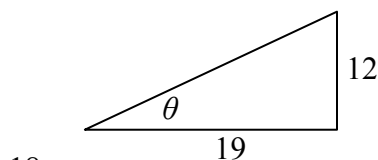
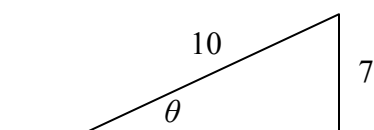

Evaluate the following expressions

- |                                                             |                                                             |
|-------------------------------------------------------------|-------------------------------------------------------------|
| 19. $\sin^{-1}\left(\cos\left(\frac{\pi}{4}\right)\right)$  | 20. $\cos^{-1}\left(\sin\left(\frac{\pi}{6}\right)\right)$  |
| 21. $\sin^{-1}\left(\cos\left(\frac{4\pi}{3}\right)\right)$ | 22. $\cos^{-1}\left(\sin\left(\frac{5\pi}{4}\right)\right)$ |
| 23. $\cos\left(\sin^{-1}\left(\frac{3}{7}\right)\right)$    | 24. $\sin\left(\cos^{-1}\left(\frac{4}{9}\right)\right)$    |
| 25. $\cos(\tan^{-1}(4))$                                    | 26. $\tan\left(\sin^{-1}\left(\frac{1}{3}\right)\right)$    |

Find a simplified expression for each of the following

- |                                                                                   |                                                                                   |
|-----------------------------------------------------------------------------------|-----------------------------------------------------------------------------------|
| 27. $\sin\left(\cos^{-1}\left(\frac{x}{5}\right)\right)$ , for $-5 \leq x \leq 5$ | 28. $\tan\left(\cos^{-1}\left(\frac{x}{2}\right)\right)$ , for $-2 \leq x \leq 2$ |
| 29. $\sin(\tan^{-1}(3x))$                                                         | 30. $\cos(\tan^{-1}(4x))$                                                         |

## Section 6.4 Solving Trig Equations

In section 6.1, we determined the height of a rider on the London Eye Ferris wheel could be determined by the equation  $h(t) = -67.5 \cos\left(\frac{\pi}{15}t\right) + 69.5$ .

If we wanted to know how long the rider is more than 100 meters above ground, we would need to solve equations involving trig functions.

### Solving using known values

In the last chapter, we learned sine and cosine values at commonly encountered angles. We can use these to solve sine and cosine equations involving these common angles.

#### Example 1

Solve  $\sin(t) = \frac{1}{2}$  for all possible values of  $t$

Notice this is asking us to identify all angles,  $t$ , that have a sine value of  $\frac{1}{2}$ . While evaluating a function always produces one result, solving can have multiple solutions.

Two solutions should immediately jump to mind from the last chapter:  $t = \frac{\pi}{6}$  and

$t = \frac{5\pi}{6}$  because they are the common angles on the unit circle.

Looking at a graph confirms that there are more than these two solutions. While eight are seen on this graph, there are an infinite number of solutions!

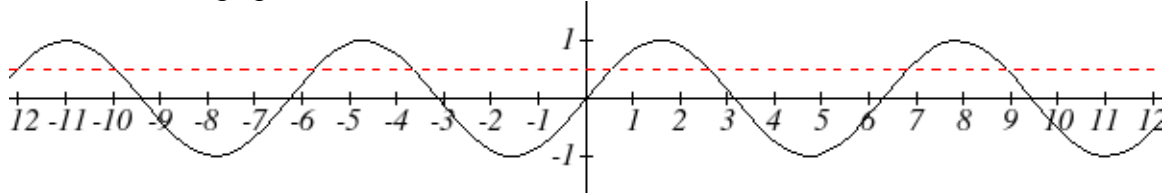

Remember that any coterminal angle will also have the same sine value, so any angle coterminal with these two is also a solution. Coterminal angles can be found by adding full rotations of  $2\pi$ , so we end up with a set of solutions:

$t = \frac{\pi}{6} + 2\pi k$  where  $k$  is an integer, and  $t = \frac{5\pi}{6} + 2\pi k$  where  $k$  is an integer

## Example 2

A circle of radius  $5\sqrt{2}$  intersects the line  $x = -5$  at two points. Find the angles  $\theta$  on the interval  $0 \leq \theta < 2\pi$ , where the circle and line intersect.

The  $x$  coordinate of a point on a circle can be found as  $x = r \cos(\theta)$ , so the  $x$  coordinate of points on this circle would be  $x = 5\sqrt{2} \cos(\theta)$ . To find where the line  $x = -5$  intersects the circle, we can solve for where the  $x$  value on the circle would be  $-5$

$$-5 = 5\sqrt{2} \cos(\theta)$$

Isolating the cosine

$$\frac{-1}{\sqrt{2}} = \cos(\theta)$$

Recall that  $\frac{-1}{\sqrt{2}} = \frac{-\sqrt{2}}{2}$ , so we are solving

$$\cos(\theta) = \frac{-\sqrt{2}}{2}$$

We can recognize this as one of our special cosine values from our unit circle, and it corresponds with angles

$$\theta = \frac{3\pi}{4} \text{ and } \theta = \frac{5\pi}{4}$$

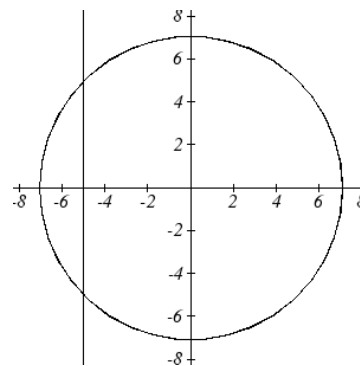

## Try it Now

1. Solve  $\tan(t) = 1$  for all possible values of  $t$

## Example 3

The depth of water at a dock rises and falls with the tide, following the equation

$f(t) = 4 \sin\left(\frac{\pi}{12}t\right) + 7$ , where  $t$  is measured in hours after midnight. A boat requires a depth of 9 feet to come to the dock. At what times will the depth be 9 feet?

To find when the depth is 9 feet, we need to solve when  $f(t) = 9$ .

$$4 \sin\left(\frac{\pi}{12}t\right) + 7 = 9$$

Isolating the sine

$$4 \sin\left(\frac{\pi}{12}t\right) = 2$$

Dividing by 4

$$\sin\left(\frac{\pi}{12}t\right) = \frac{1}{2}$$

We know  $\sin(\theta) = \frac{1}{2}$  when  $\theta = \frac{\pi}{6}$  or  $\theta = \frac{5\pi}{6}$

While we know what angles have a sine value of  $\frac{1}{2}$ , because of the horizontal stretch/compression, it is less clear how to proceed.

To deal with this, we can make a substitution, defining a new temporary variable  $u$  to be

$u = \frac{\pi}{12}t$ , so our equation becomes

$$\sin(u) = \frac{1}{2}$$

From earlier, we saw the solutions to this equation were

$$u = \frac{\pi}{6} + 2\pi k \text{ where } k \text{ is an integer, and}$$

$$u = \frac{5\pi}{6} + 2\pi k \text{ where } k \text{ is an integer}$$

Undoing our substitution, we can replace the  $u$  in the solutions with  $u = \frac{\pi}{12}t$  and solve for  $t$ .

$$\frac{\pi}{12}t = \frac{\pi}{6} + 2\pi k \text{ where } k \text{ is an integer, and } \frac{\pi}{12}t = \frac{5\pi}{6} + 2\pi k \text{ where } k \text{ is an integer.}$$

Dividing by  $\pi/12$ , we obtain solutions

$$t = 2 + 24k \text{ where } k \text{ is an integer, and}$$

$$t = 10 + 24k \text{ where } k \text{ is an integer.}$$

The depth will be 9 feet and boat will be able to sail between 2am and 10am.

Notice how in both scenarios, the  $24k$  shows how every 24 hours the cycle will be repeated.

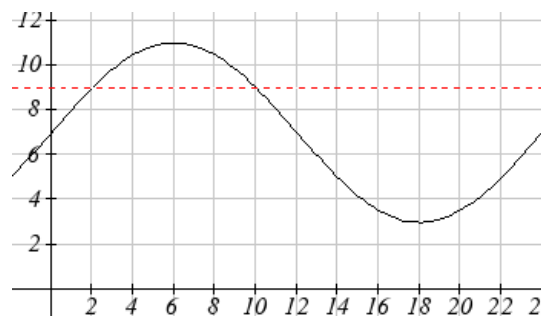

In the previous example, looking back at the original simplified equation  $\sin\left(\frac{\pi}{12}t\right) = \frac{1}{2}$ , we can use the ratio of the “normal period” to the stretch factor to find the period.

$$\frac{2\pi}{\left(\frac{\pi}{12}\right)} = 2\pi\left(\frac{12}{\pi}\right) = 24; \text{ notice that the sine function has a period of } 24, \text{ which is reflected}$$

in the solutions; there were two unique solutions on one full cycle of the sine function, and additional solutions were found by adding multiples of a full period.

### Try it Now

2. Solve  $4\sin(5t) - 1 = 1$  for all possible values of  $t$

**Solving using the inverse trig functions**

The solutions to  $\sin(\theta) = 0.3$  cannot be expressed in terms of functions we already know. To represent the solutions, we need the inverse sine function that “undoes” the sine function.

**Example 4**

Use the inverse to find one solution to  $\sin(\theta) = 0.8$

Since this is not a known unit circle value, calculating the inverse,  $\theta = \sin^{-1}(0.8)$ . This requires a calculator and we must approximate a value for this angle. If your calculator is in degree mode, your calculator will give you a degree angle as the output. If your calculator is in radian mode, your calculator will give you a radian angle as the output. In radians,  $\theta = \sin^{-1}(0.8) \approx 0.927$ , or in degrees,  $\theta = \sin^{-1}(0.8) \approx 53.130^\circ$

If you are working with a composed trig function and you are not solving for an angle, you will want to ensure that you are working in radians. Since radians are a unitless measure, they don't intermingle with the result the way degrees would.

Notice that the inverse trig functions do exactly what you would expect of any function – for each input they give exactly one output. While this is necessary for these to be a function, it means that to find *all* the solutions to an equation like  $\sin(\theta) = 0.8$ , we need to do more than just evaluate the inverse.

**Example 5**

Find all solutions to  $\sin(\theta) = 0.8$ .

We would expect two unique angles on one cycle to have this sine value. In the previous example, we found one solution to be  $\theta = \sin^{-1}(0.8) \approx 0.927$ . To find the other, we need to answer the question “what other angle has the same sine value as an angle of 0.927?” On a unit circle, we would recognize that the second angle would have the same reference angle and reside in the second quadrant. This second angle would be located at  $\theta = \pi - 0.927 = 2.214$ . To find more solutions we recall that angles coterminal with these two would have the same sine value, so we can add full cycles of  $2\pi$ .

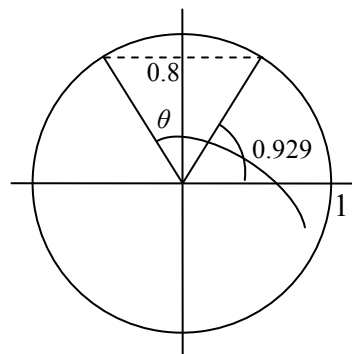

$\theta = 0.927 + 2\pi k$  where  $k$  is an integer, and  $\theta = 2.214 + 2\pi k$  where  $k$  is an integer

## Example 6

Find all solutions to  $\sin(x) = -\frac{8}{9}$  on the interval  $0^\circ \leq x < 360^\circ$

First we will turn our calculator to degree mode. Using the inverse, we can find a first solution  $x = \sin^{-1}\left(-\frac{8}{9}\right) \approx -62.734^\circ$ . While this angle satisfies the equation, it does not lie in the domain we are looking for. To find the angles in the desired domain, we start looking for additional solutions.

First, an angle coterminal with  $-62.734^\circ$  will have the same sine. By adding a full rotation, we can find an angle in the desired domain with the same sine.

$$x = -62.734^\circ + 360^\circ = 297.266^\circ$$

There is a second angle in the desired domain that lies in the third quadrant. Notice that  $62.734^\circ$  is the reference angle for all solutions, so this second solution would be  $62.734^\circ$  past  $180^\circ$

$$x = 62.734^\circ + 180^\circ = 242.734^\circ$$

The two solutions on  $0^\circ \leq x < 360^\circ$  are  $x = 297.266^\circ$  and  $x = 242.734^\circ$

## Example 7

Find all solutions to  $\tan(x) = 3$  on  $0 \leq x < 2\pi$

Using the inverse, we can find a first solution  $x = \tan^{-1}(3) \approx 1.249$ . Unlike the sine and cosine, the tangent function only reaches any output value once per cycle, so there is not a second solution on one period of the tangent.

By adding  $\pi$ , a full period of tangent function, we can find a second angle with the same tangent value. If additional solutions were desired, we could continue to add multiples of  $\pi$ , so all solutions would take on the form  $x = 1.249 + k\pi$ , however we are only interested in  $0 \leq x < 2\pi$ .

$$x = 1.249 + \pi = 4.391$$

The two solutions on  $0 \leq x < 2\pi$  are  $x = 1.249$  and  $x = 4.391$

## Try it Now

3. Find all solutions to  $\tan(x) = 0.7$  on  $0^\circ \leq x < 360^\circ$

## Example 8

Solve  $3 \cos(t) + 4 = 2$  for all solutions on one cycle,  $0 \leq t < 2\pi$

$$3 \cos(t) + 4 = 2 \quad \text{Isolating the cosine}$$

$$3 \cos(t) = -2$$

$$\cos(t) = -\frac{2}{3} \quad \text{Using the inverse, we can find a first solution}$$

$$t = \cos^{-1}\left(-\frac{2}{3}\right) \approx 2.301$$

Thinking back to the circle, the second angle with the same cosine would be located in the third quadrant. Notice that the location of this angle could be represented as  $t = -2.301$ . To represent this as a positive angle we could find a coterminal angle by adding a full cycle.

$$t = -2.301 + 2\pi = 3.982$$

The equation has two solutions on one cycle, at  $t = 2.301$  and  $t = 3.982$

## Example 9

Solve  $\cos(3t) = 0.2$  for all solutions on two cycles,  $0 \leq t < \frac{4\pi}{3}$

As before, with a horizontal compression it can be helpful to make a substitution,  $u = 3t$ . Making this substitution simplifies the equation to a form we have already solved.

$$\cos(u) = 0.2$$

$$u = \cos^{-1}(0.2) \approx 1.369$$

A second solution on one cycle would be located in the fourth quadrant with the same reference angle.

$$u = 2\pi - 1.369 = 4.914$$

In this case, we need all solutions on two cycles, so we need to find the solutions on the second cycle. We can do this by adding a full rotation to the previous two solutions.

$$u = 1.369 + 2\pi = 7.653$$

$$u = 4.914 + 2\pi = 11.197$$

Undoing the substitution, we obtain our four solutions:

$$3t = 1.369, \text{ so } t = 0.456$$

$$3t = 4.914 \text{ so } t = 1.638$$

$$3t = 7.653, \text{ so } t = 2.551$$

$$3t = 11.197, \text{ so } t = 3.732$$



## Example 10

Solve  $3\sin(\pi t) = -2$  for all solutions

$$3\sin(\pi t) = -2$$

Isolating the sine

$$\sin(\pi t) = -\frac{2}{3}$$

We make the substitution  $u = \pi t$ 

$$\sin(u) = -\frac{2}{3}$$

Using the inverse, we find one solution

$$u = \sin^{-1}\left(-\frac{2}{3}\right) \approx -0.730$$

This angle is in the fourth quadrant. A second angle with the same sine would be in the third quadrant:

$$u = \pi + 0.730 = 3.871$$

We can write all solutions to the equation  $\sin(u) = -\frac{2}{3}$  as

$$u = -0.730 + 2\pi k \text{ where } k \text{ is an integer, and}$$

$$u = 3.871 + 2\pi k$$

Undoing our substitution, we can replace  $u$  in our solutions with  $u = \pi t$  and solve for  $t$ 

$$\pi t = -0.730 + 2\pi k \quad \text{and} \quad \pi t = 3.871 + 2\pi k \quad \text{Divide by } \pi$$

$$t = -0.232 + 2k \quad \text{and} \quad t = 1.232 + 2k$$

## Try it Now

4. Solve  $5\sin\left(\frac{\pi}{2}t\right) + 3 = 0$  for all solutions on one cycle.  $0 \leq t < 2\pi$

## Definition

**Solving Trig Equations**

- 1) Isolate the trig function on one side of the equation
- 2) Make a substitution for the inside of the sine or cosine
- 3) Use the inverse trig functions to find one solution
- 4) Use symmetries to find a second solution on one cycle (when a second exists)
- 5) Find additional solutions if needed by adding full periods
- 6) Undo the substitution

We now can return to the question we began the section with.

## Example 10

The height of a rider on the London Eye Ferris wheel can be determined by the equation  $h(t) = -67.5 \cos\left(\frac{\pi}{15}t\right) + 69.5$ . How long is the rider more than 100 meters above ground?

To find how long the rider is above 100 meters, we first solve for the times at which the rider is at a height of 100 meters by solving  $h(t) = 100$ .

$$100 = -67.5 \cos\left(\frac{\pi}{15}t\right) + 69.5 \quad \text{Isolating the cosine}$$

$$30.5 = -67.5 \cos\left(\frac{\pi}{15}t\right)$$

$$\frac{30.5}{-67.5} = \cos\left(\frac{\pi}{15}t\right) \quad \text{We make the substitution } u = \frac{\pi}{15}t$$

$$\frac{30.5}{-67.5} = \cos(u) \quad \text{Using the inverse, we find one solution}$$

$$u = \cos^{-1}\left(\frac{30.5}{-67.5}\right) \approx 2.040$$

This angle is in the second quadrant. A second angle with the same cosine would be symmetric in the third quadrant.

$$u = 2\pi - 2.040 \approx 4.244$$

Now we can undo the substitution to solve for  $t$

$$\frac{\pi}{15}t = 2.040 \quad \text{so } t = 9.740 \text{ minutes}$$

$$\frac{\pi}{15}t = 4.244 \quad \text{so } t = 20.264 \text{ minutes}$$

A rider will be at 100 meters after 9.740 minutes, and again after 20.264. From the behavior of the height graph, we know the rider will be above 100 meters between these times. A rider will be above 100 meters for  $20.265 - 9.740 = 10.523$  minutes of the ride.

## Important Topics of This Section

Solving trig equations using known values

Using substitution to solve equations

Finding answers in one cycle or period vs Finding all possible solutions

Method for solving trig equations

## Try it Now Answers

1.  $\frac{\pi}{4} + \pi k$
2.  $t = \frac{\pi}{30} + \frac{2\pi}{5}k$        $t = \frac{\pi}{6} + \frac{2\pi}{5}k$
3.  $x = 34.992^\circ$  or  $x = 180^\circ + 34.99^\circ = 214.992^\circ$
4.  $t = 3.590$  or  $t = 2.410$

**Section 6.4 Exercises**Find all solutions on the interval  $0 \leq \theta < 2\pi$ 

1.  $2 \sin(\theta) = -\sqrt{2}$     2.  $2 \sin(\theta) = \sqrt{3}$     3.  $2 \cos(\theta) = 1$     4.  $2 \cos(\theta) = -\sqrt{2}$   
 5.  $\sin(\theta) = 1$     6.  $\sin(\theta) = 0$     7.  $\cos(\theta) = 0$     8.  $\cos(\theta) = -1$

Find all solutions

9.  $2 \cos(\theta) = \sqrt{2}$     10.  $2 \cos(\theta) = -1$     11.  $2 \sin(\theta) = -1$     12.  $2 \sin(\theta) = -\sqrt{3}$

Find all solutions

13.  $2 \sin(3\theta) = 1$     14.  $2 \sin(2\theta) = \sqrt{3}$     15.  $2 \sin(3\theta) = -\sqrt{2}$   
 16.  $2 \sin(3\theta) = -1$     17.  $2 \cos(2\theta) = 1$     18.  $2 \cos(2\theta) = \sqrt{3}$   
 19.  $2 \cos(3\theta) = -\sqrt{2}$     20.  $2 \cos(2\theta) = -1$     21.  $\cos\left(\frac{\pi}{4}\theta\right) = -1$   
 22.  $\sin\left(\frac{\pi}{3}\theta\right) = -1$     23.  $2 \sin(\pi\theta) = 1$     24.  $2 \cos\left(\frac{\pi}{5}\theta\right) = \sqrt{3}$

Find all solutions on the interval  $0 \leq x < 2\pi$ 

25.  $\sin(x) = 0.27$     26.  $\sin(x) = 0.48$     27.  $\sin(x) = -0.58$     28.  $\sin(x) = -0.34$   
 29.  $\cos(x) = -0.55$     30.  $\sin(x) = 0.28$     31.  $\cos(x) = 0.71$     32.  $\cos(x) = -0.07$

Find the first two positive solutions

33.  $7 \sin(6x) = 2$     34.  $7 \sin(5x) = 6$     35.  $5 \cos(3x) = -3$     36.  $3 \cos(4x) = 2$   
 37.  $3 \sin\left(\frac{\pi}{4}x\right) = 2$     38.  $7 \sin\left(\frac{\pi}{5}x\right) = 6$     39.  $5 \cos\left(\frac{\pi}{3}x\right) = 1$     40.  $3 \cos\left(\frac{\pi}{2}x\right) = -2$

## Section 6.5 Modeling with Trigonometric Equations

### Solving right triangles for angles

In section 5.5, we worked with trigonometry on a right triangle to solve for the sides of a triangle given one side and an additional angle. Using the inverse trig functions, we can solve for the angles of a right triangle given two sides.

#### Example 1

An airplane needs to fly to an airfield located 300 miles east and 200 miles north of its current location. At what heading should the airplane fly? In other words, if we ignore air resistance or wind speed, how many degrees north of east should the airplane fly?

We might begin by drawing a picture and labeling all of the known information. Drawing a triangle, we see we are looking for the angle  $\alpha$ . In this triangle, the side opposite the angle  $\alpha$  is 200 miles and the side adjacent is 300 miles. Since we know the values for the opposite and adjacent sides, it makes sense to use the tangent function.

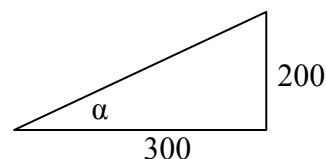

$$\tan(\alpha) = \frac{200}{300} \quad \text{Using the inverse,}$$

$$\alpha = \tan^{-1}\left(\frac{200}{300}\right) \approx 0.588, \text{ or equivalently about } 33.7 \text{ degrees.}$$

The airplane needs to fly at a heading of 33.7 degrees north of east.

#### Example 2

OSHA safety regulations require that the base of a ladder be placed 1 foot from the wall for every 4 feet of ladder length<sup>3</sup>. Find the angle the ladder forms with the ground.

For any length of ladder, the base needs to be  $\frac{1}{4}$  of that away from the wall. Equivalently, if the base is  $a$  feet from the wall, the ladder can be  $4a$  feet long. Since  $a$  is the side adjacent to the angle and  $4a$  is the hypotenuse, we use the cosine function.

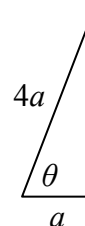

$$\cos(\theta) = \frac{a}{4a} = \frac{1}{4} \quad \text{Using the inverse}$$

$$\theta = \cos^{-1}\left(\frac{1}{4}\right) \approx 75.52 \text{ degrees}$$

The ladder forms a 75.52 degree angle with the ground.

<sup>3</sup> <http://www.osha.gov/SLTC/etools/construction/falls/4ladders.html>

## Try it Now

- One of the cables that anchor to the center of the London Eye Ferris wheel to the ground must be replaced. The center of the Ferris wheel is 69.5 meters above the ground and the second anchor on the ground is 23 meters from the base of the Ferris wheel. What is the angle of elevation (from ground up to the center of the Ferris wheel) and how long is the cable?

## Example 3

In a video game design, a map shows the location of other characters relative to the player, who is situated at the origin, and the direction they are facing. A character currently shows on the map at coordinates  $(-3, 5)$ . If the player rotates counterclockwise by 20 degrees, then the objects in the map will correspondingly rotate 20 degrees clockwise. Find the new coordinates of the character.

To rotate the position of the character, we can imagine it as a point on a circle, and we will change the angle of the point by 20 degrees. To do so, we first need to find the radius of this circle and the original angle.

Drawing a triangle in the circle, we can find the radius using Pythagorean Theorem:

$$(-3)^2 + 5^2 = r^2$$

$$r = \sqrt{9 + 25} = \sqrt{34}$$

To find the angle, we need to decide first if we are going to find the acute angle of the triangle, the reference angle, or if we are going to find the angle measured in standard position. While either approach will work, in this case we will do the latter. Since for any point on a circle we know  $x = r \cos(\theta)$ , adding our given information we get

$$-3 = \sqrt{34} \cos(\theta)$$

$$\frac{-3}{\sqrt{34}} = \cos(\theta)$$

$$\theta = \cos^{-1}\left(\frac{-3}{\sqrt{34}}\right) \approx 120.964^\circ$$

While there are two angles that have this cosine value, the angle of 120.964 degrees is in the second quadrant as desired, so it is the angle we were looking for.

Rotating the point clockwise by 20 degrees, the angle of the point will decrease to 100.964 degrees. We can then evaluate the coordinates of the rotated point

$$x = \sqrt{34} \cos(100.964^\circ) \approx -1.109$$

$$y = \sqrt{34} \sin(100.964^\circ) \approx 5.725$$

The coordinates of the character on the rotated map will be  $(-1.109, 5.725)$

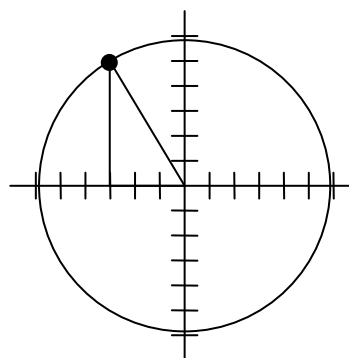

### Modeling with sinusoidal functions

Many modeling situations involve functions that are periodic. Previously we learned that sinusoidal functions are a special type of periodic function. Problems that involve quantities that oscillate can often be modeled by a sine or cosine function and once we create a suitable model for the problem we can use the equation and function values to answer the question.

#### Example 4

The hours of daylight in Seattle oscillate from a low of 8.5 hours in January to a high of 16 hours in July<sup>4</sup>. When should you plant a garden if you want to do it during the month where there are 14 hours of daylight?

To model this, we first note that the hours of daylight oscillate with a period of 12 months. With a low of 8.5 and a high of 16, the midline will be halfway between these values, at  $\frac{16+8.5}{2} = 12.25$ . The amplitude will be half the difference between the

highest and lowest values:  $\frac{16-8.5}{2} = 3.75$ , or equivalently the distance from the midline to the high or low value,  $16-12.25=3.75$ . Letting January be  $t = 0$ , the graph starts at the lowest value, so it can be modeled as a flipped cosine graph. Putting this together, we get a model:

$$h(t) = -3.75 \cos\left(\frac{\pi}{6}t\right) + 12.25$$

$-\cos(t)$  represents the flipped cosine,

3.75 is the amplitude,

12.25 is the midline,

$2\pi/12 = \pi/6$  corresponds to the horizontal stretch, found by using the ratio of the “original period / new period”

$h(t)$  is our model for hours of day light  $t$  months from January.

To find when there will be 14 hours of daylight, we solve  $h(t) = 14$ .

$$14 = -3.75 \cos\left(\frac{\pi}{6}t\right) + 12.25 \quad \text{Isolating the cosine}$$

$$1.75 = -3.75 \cos\left(\frac{\pi}{6}t\right) \quad \text{Subtracting 12.25 and dividing by -3.75}$$

$$-\frac{1.75}{3.75} = \cos\left(\frac{\pi}{6}t\right) \quad \text{Using the inverse}$$

<sup>4</sup> <http://www.mountaineers.org/seattle/climbing/Reference/DaylightHrs.html>

$$\frac{\pi}{6}t = \cos^{-1}\left(-\frac{1.75}{3.75}\right) \approx 2.0563 \quad \text{multiplying by the reciprocal}$$

$$t = 2.0563 \cdot \frac{6}{\pi} = 3.927 \quad t=3.927 \text{ months past January}$$

There will be 14 hours of daylight 3.927 months into the year, or near the end of April.

While there would be a second time in the year when there are 14 hours of daylight, since we are planting a garden, we would want to know the first solution, in spring, so we do not need to find the second solution in this case.

### Try it Now

2. The author's monthly gas usage (in therms) is shown here. Find an equation to model the data.

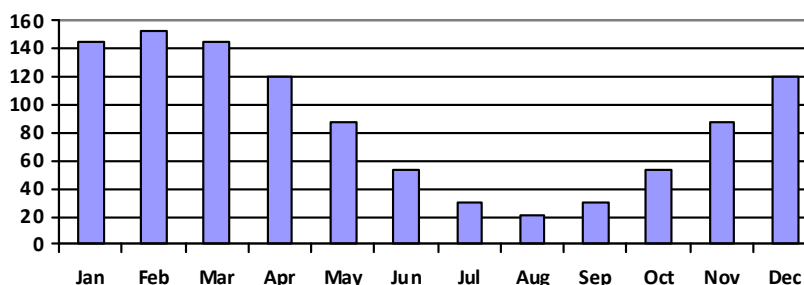

### Example 6

An object is connected to the wall with a spring that has a natural length of 20 cm. The object is pulled back 8 cm past the natural length and released. The object oscillates 3 times per second. Find an equation for the position of the object ignoring the effects of friction. How much time in each cycle is the object more than 27 cm from the wall?



If we use the distance from the wall,  $x$ , as the desired output, then the object will oscillate equally on either side of the spring's natural length of 20, putting the midline of the function at 20 cm.

If we release the object 8 cm past the natural length, the amplitude of the oscillation will be 8 cm.

We are beginning at the largest value and so this function can most easily be modeled using a cosine function.

Since the object oscillates 3 times per second, it has a frequency of 3 and the period of one oscillation is  $1/3$  of second. Using this we find the horizontal compression using the

$$\text{ratios of the periods } \frac{2\pi}{1/3} = 6\pi$$



Using all this, we can build our model:

$$x(t) = 8\cos(6\pi t) + 20$$

To find when the object is 27 cm from the wall, we can solve  $x(t) = 27$

$$27 = 8\cos(6\pi t) + 20 \quad \text{Isolating the cosine}$$

$$7 = 8\cos(6\pi t)$$

$$\frac{7}{8} = \cos(6\pi t) \quad \text{Using the inverse}$$

$$6\pi t = \cos^{-1}\left(\frac{7}{8}\right) \approx 0.505$$

$$t = \frac{0.505}{6\pi} = 0.0268$$

Based on the shape of the graph, we can conclude that the object will spend the first 0.0268 seconds more than 27 cm from the wall. Based on the symmetry of the function, the object will spend another 0.0268 seconds more than 27 cm from the wall at the end of the cycle. Altogether, the object spends 0.0536 seconds each cycle more than 27 cm from the wall.

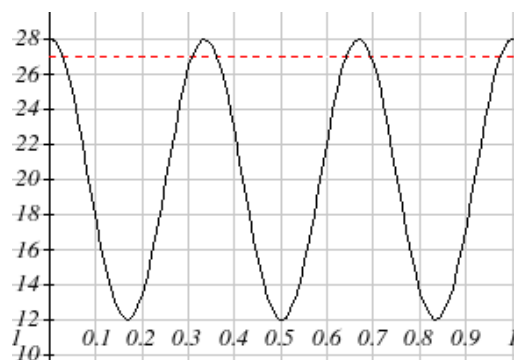

In some problems, we can use the trigonometric functions to model behaviors more complicated than the basic sinusoidal function.

### Example 7

A rigid rod with length 10 cm is attached to a circle of radius 4 cm at point  $A$  as shown here. The point  $B$  is able to freely move along the horizontal axis, driving a piston<sup>5</sup>. If the wheel rotates counterclockwise at 5 revolutions per minute, find the location of point  $B$  as a function of time. When will the point  $B$  be 12 cm from the center of the circle?

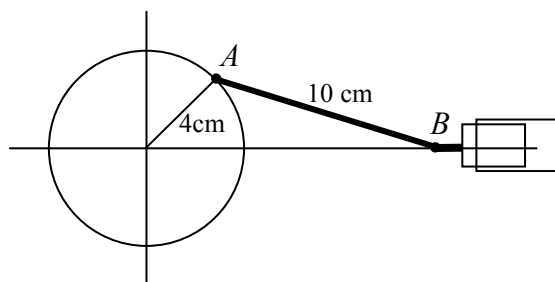

To find the position of point  $B$ , we can begin by finding the coordinates of point  $A$ . Since it is a point on a circle with radius 4, we can express its coordinates as  $(4\cos(\theta), 4\sin(\theta))$ .

<sup>5</sup> For an animation of this situation, see <http://mathdemos.gcsu.edu/mathdemos/sinusoidapp/engine1.gif>

The angular velocity is 5 revolutions per second, or equivalently  $10\pi$  radians per second. After  $t$  seconds, the wheel will rotate by  $\theta = 10\pi t$  radians. Substituting this, we can find the coordinates of  $A$  in terms of  $t$ .

$$(4 \cos(10\pi t), 4 \sin(10\pi t))$$

Notice that this is the same value we would have obtained by noticing that the period of the rotation is  $1/5$  of a second and calculating the stretch/compression factor

$$\frac{\text{"original"} \ 2\pi}{\text{"new"} \ 1/5} = 10\pi.$$

Now that we have the coordinates of the point  $A$ , we can relate this to the point  $B$ . By drawing a vertical line from  $A$  to the horizontal axis, we can form a triangle. The height of the triangle is the  $y$  coordinate of the point  $A$ :  $4 \sin(10\pi t)$ . Using the Pythagorean Theorem, we can find the base length of the triangle:

$$(4 \sin(10\pi t))^2 + b^2 = 10^2$$

$$b^2 = 100 - 16 \sin^2(10\pi t)$$

$$b = \sqrt{100 - 16 \sin^2(10\pi t)}$$

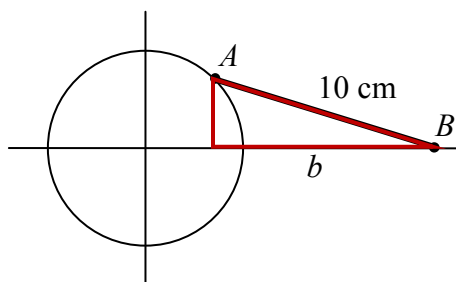

Looking at the  $x$  coordinate of the point  $A$ , we can see that the triangle we drew is shifted to the right of the  $y$  axis by  $4 \cos(10\pi t)$ . Combining this offset with the length of the base of the triangle gives the  $x$  coordinate of the point  $B$ :

$$x(t) = 4 \cos(10\pi t) + \sqrt{100 - 16 \sin^2(10\pi t)}$$

To solve for when the point  $B$  will be 12 cm from the center of the circle, we need to solve  $x(t) = 12$ .

$$12 = 4 \cos(10\pi t) + \sqrt{100 - 16 \sin^2(10\pi t)}$$

Isolate the square root

$$12 - 4 \cos(10\pi t) = \sqrt{100 - 16 \sin^2(10\pi t)}$$

Square both sides

$$(12 - 4 \cos(10\pi t))^2 = 100 - 16 \sin^2(10\pi t)$$

Expand the left side

$$144 - 96 \cos(10\pi t) + 16 \cos^2(10\pi t) = 100 - 16 \sin^2(10\pi t)$$

Move terms of the left

$$44 - 96 \cos(10\pi t) + 16 \cos^2(10\pi t) + 16 \sin^2(10\pi t) = 0$$

Factor out 16

$$44 - 96 \cos(10\pi t) + 16(\cos^2(10\pi t) + \sin^2(10\pi t)) = 0$$

At this point, we can utilize the Pythagorean Identity, which tells us that  $\cos^2(10\pi t) + \sin^2(10\pi t) = 1$ .

Using this identity, our equation simplifies to

$$44 - 96 \cos(10\pi t) + 16 = 0$$

Combine the constants and move to the right side

$$-96 \cos(10\pi t) = -60$$

Divide

$$\cos(10\pi t) = \frac{60}{96}$$

Make a substitution

$$\cos(u) = \frac{60}{96}$$

$$u = \cos^{-1}\left(\frac{60}{96}\right) \approx 0.896$$

By symmetry we can find a second solution

$$u = 2\pi - 0.896 = 5.388$$

Undoing the substitution

$$10\pi t = 0.896, \text{ so } t = 0.0285$$

$$10\pi t = 5.388, \text{ so } t = 0.1715$$

The point  $B$  will be 12 cm from the center of the circle after 0.0285 seconds, 0.1715 seconds, and every  $1/5^{\text{th}}$  of a second after each of those values.

### Important Topics of This Section

Modeling with trig equations

Modeling with sinusoidal functions

Solving right triangles for angles in degrees and radians

### Try it Now Answers

1. Angle of elevation for the cable is 71.69 degrees and the cable is 73.21 m long

2. Approximately  $G(t) = 66 \cos\left(\frac{\pi}{6}(t-1)\right) + 87$

### Section 6.5 Exercises

In each of the following triangles, solve for the unknown side and angles.

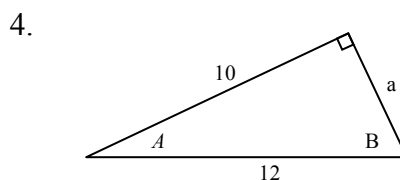
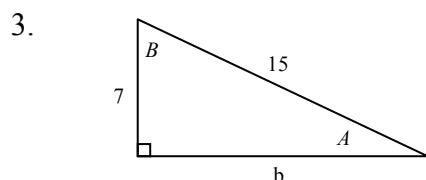
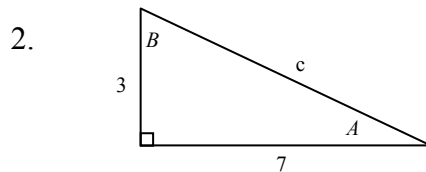
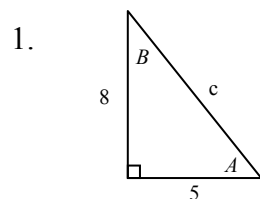

Find a possible formula for the trigonometric function whose values are in the following tables.

5.

<b>x</b>	0	1	2	3	4	5	6
<b>y</b>	-2	4	10	4	-2	4	10

6.

<b>x</b>	0	1	2	3	4	5	6
<b>y</b>	1	-3	-7	-3	1	-3	-7

7. Outside temperature over a day can be modeled as a sinusoidal function. Suppose you know the high temperature for the day is 63 degrees and the low temperature of 37 degrees occurs at 5 AM. Assuming  $t$  is the number of hours since midnight, find an equation for the temperature,  $D$ , in terms of  $t$ .

8. Outside temperature over a day can be modeled as a sinusoidal function. Suppose you know the high temperature for the day is 92 degrees and the low temperature of 78 degrees occurs at 4 AM. Assuming  $t$  is the number of hours since midnight, find an equation for the temperature,  $D$ , in terms of  $t$ .

9. A population of rabbits oscillates 25 above and below an average of 129 during the year, hitting the lowest value in January ( $t = 0$ ).

- Find an equation for the population,  $P$ , in terms of the months since January,  $t$ .
- What if the lowest value of the rabbit population occurred in April instead?

10. A population of elk oscillates 150 above and below an average of 720 during the year, hitting the lowest value in January ( $t = 0$ ).
- Find an equation for the population,  $P$ , in terms of the months since January,  $t$ .
  - What if the lowest value of the rabbit population occurred in March instead?
11. Outside temperature over a day can be modeled as a sinusoidal function. Suppose you know the high temperature of 105 degrees occurs at 5 PM and the average temperature for the day is 85 degrees. Find the temperature, to the nearest degree, at 9 AM.
12. Outside temperature over a day can be modeled as a sinusoidal function. Suppose you know the high temperature of 84 degrees occurs at 6 PM and the average temperature for the day is 70 degrees. Find the temperature, to the nearest degree, at 7 AM.
13. Outside temperature over a day can be modeled as a sinusoidal function. Suppose you know the temperature varies between 47 and 63 degrees during the day and the average daily temperature first occurs at 10 AM. How many hours after midnight does the temperature first reach 51 degrees?
14. Outside temperature over a day can be modeled as a sinusoidal function. Suppose you know the temperature varies between 64 and 86 degrees during the day and the average daily temperature first occurs at 12 AM. How many hours after midnight does the temperature first reach 70 degrees?
15. A Ferris wheel is 20 meters in diameter and boarded from a platform that is 2 meters above the ground. The six o'clock position on the Ferris wheel is level with the loading platform. The wheel completes 1 full revolution in 6 minutes. How many minutes of the ride are spent higher than 13 meters above the ground?
16. A Ferris wheel is 45 meters in diameter and boarded from a platform that is 1 meters above the ground. The six o'clock position on the Ferris wheel is level with the loading platform. The wheel completes 1 full revolution in 10 minutes. How many minutes of the ride are spent higher than 27 meters above the ground?
17. The sea ice area around the north pole fluctuates between about 6 million square kilometers in September to 14 million square kilometers in March. During how many months are there less than 9 million square kilometers of sea ice?
18. The sea ice area around the south pole fluctuates between about 18 million square kilometers in September to 3 million square kilometers in March. During how many months are there more than 15 million square kilometers of sea ice?

19. A respiratory ailment called “Cheyne-Stokes Respiration” causes the volume per breath to increase and decrease in a sinusoidal manner, as a function of time. For one particular patient with this condition, a machine begins recording a plot of volume per breath versus time (in seconds). Let  $b(t)$  be a function of time  $t$  that tells us the volume (in liters) of a breath that starts at time  $t$ . During the test, the smallest volume per breath is 0.6 liters and this first occurs for a breath that starts 5 seconds into the test. The largest volume per breath is 1.8 liters and this first occurs for a breath beginning 55 seconds into the test. [UW]

- Find a formula for the function  $b(t)$  whose graph will model the test data for this patient.
- If the patient begins a breath every 5 seconds, what are the breath volumes during the first minute of the test?

20. Suppose the high tide in Seattle occurs at 1:00 a.m. and 1:00 p.m. at which time the water is 10 feet above the height of low tide. Low tides occur 6 hours after high tides. Suppose there are two high tides and two low tides every day and the height of the tide varies sinusoidally. [UW]

- Find a formula for the function  $y=h(t)$  that computes the height of the tide above low tide at time  $t$ . (In other words,  $y=0$  corresponds to low tide.)
- What is the tide height at 11:00 a.m.?

21. A communications satellite orbits the earth  $t$  miles above the surface. Assume the radius of the earth is 3,960 miles. The satellite can only “see” a portion of the earth’s surface, bounded by what is called a horizon circle. This leads to a two-dimensional cross-sectional picture we can use to study the size of the horizon slice: [UW]

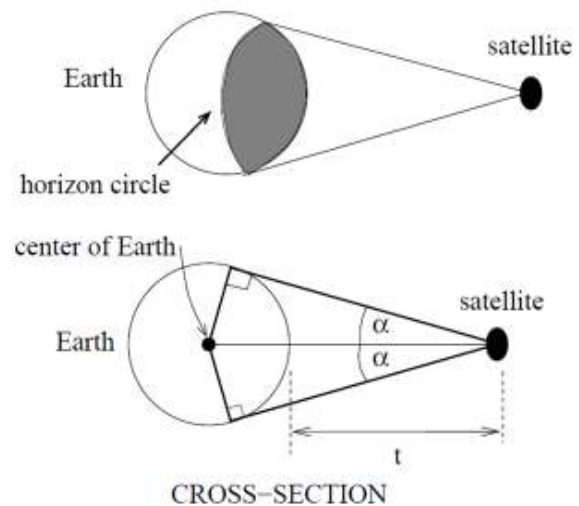

- Find a formula for  $\alpha$  in terms of  $t$ .
- If  $t = 30,000$  miles, what is  $\alpha$ ? What percentage of the circumference of the earth is covered by the satellite? What would be the minimum number of such satellites required to cover the circumference?
- If  $t = 1,000$  miles, what is  $\alpha$ ? What percentage of the circumference of the earth is covered by the satellite? What would be the minimum number of such satellites required to cover the circumference?
- Suppose you wish to place a satellite into orbit so that 20% of the circumference is covered by the satellite. What is the required distance  $t$ ?

22. Tiffany is a model rocket enthusiast. She has been working on a pressurized rocket filled with laughing gas. According to her design, if the atmospheric pressure exerted on the rocket is less than 10 pounds/sq.in., the laughing gas chamber inside the rocket will explode. Tiff worked from a formula  $p = 14.7e^{-h/10}$  pounds/sq.in. for the atmospheric pressure  $h$  miles above sea level. Assume that the rocket is launched at an angle of  $\alpha$  above level ground at sea level with an initial speed of 1400 feet/sec. Also, assume the height (in feet) of the rocket at time  $t$  seconds is given by the equation

$$y(t) = -16t^2 + 1400 \sin(\alpha)t \quad [\text{UW}]$$

- a. At what altitude will the rocket explode?
- b. If the angle of launch is  $\alpha = 12^\circ$ , determine the minimum atmospheric pressure exerted on the rocket during its flight. Will the rocket explode in midair?
- c. If the angle of launch is  $\alpha = 82^\circ$ , determine the minimum atmospheric pressure exerted on the rocket during its flight. Will the rocket explode in midair?
- d. Find the largest launch angle  $\alpha$  so that the rocket will not explode.

